

ANNALI DELLA
SCUOLA NORMALE SUPERIORE DI PISA
Classe di Scienze

ANTONIO MARINO

CLAUDIO SACCON

**Some variational theorems of mixed type and elliptic
problems with jumping nonlinearities**

*Annali della Scuola Normale Superiore di Pisa, Classe di Scienze 4^e série, tome 25,
n° 3-4 (1997), p. 631-665*

http://www.numdam.org/item?id=ASNSP_1997_4_25_3-4_631_0

© Scuola Normale Superiore, Pisa, 1997, tous droits réservés.

L'accès aux archives de la revue « Annali della Scuola Normale Superiore di Pisa, Classe di Scienze » (<http://www.sns.it/it/edizioni/riviste/annaliscienze/>) implique l'accord avec les conditions générales d'utilisation (<http://www.numdam.org/conditions>). Toute utilisation commerciale ou impression systématique est constitutive d'une infraction pénale. Toute copie ou impression de ce fichier doit contenir la présente mention de copyright.

NUMDAM

Article numérisé dans le cadre du programme
Numérisation de documents anciens mathématiques
<http://www.numdam.org/>

Some Variational Theorems of Mixed Type and Elliptic Problems with Jumping Nonlinearities

ANTONIO MARINO – CLAUDIO SACCON

Dedicated to Ennio De Giorgi

1. – Introduction

The study of multiplicity of solutions of some asymptotically non symmetric semilinear elliptic problems (jumping nonlinearities) has turned out to be a very interesting subject. One reason is that there is a large variety of behaviours exhibited by the functional whose critical points are the sought for solutions.

In the recent paper [34] some abstract variational theorems were individuated, which permitted to develop a unified approach for several known results and to prove new ones (we give some few details about them in Section 3). In [34] a “map” was drawn (see page 294 therein), which summarized the multiplicity results proved in that paper, and several previous ones.

In this work we present some new variational theorems, which in particular allowed us to get new multiplicity results for jumping problems, which were, in some sense, suggested by the above mentioned map.

We are going to expose the abstract theorems in Section 2, since it seems to us that they are interesting in itself and useful for treating other nonlinear problems.

A common feature of the theorems of Section 2, we wish to point out here, is that they are of “mixed type” as they contain assumptions concerning both the values of the involved function f on some sets, and the direction of the gradient of f on some subspaces. This theorems ensure the existence of a certain number (greater than one) of critical points for f , which cannot, in general, be distinguished by the value of f (when critical values coincide there are infinitely many critical points).

We notice that, removing the assumptions on the gradient, one could prove the existence of the same number of critical points, provided it were a priori known that the critical points are non degenerate.

All the mentioned theorems are preceded by corresponding lemmas where it is proved that a functional defined on a suitable “homologically relevant” (one-

side) constraint has a certain number of (lower) critical points, which in general is greater than the number of critical levels. Actually, in the theorems, the assumption on the gradient is used to “simulate” the existence of the constraint used in the lemmas.

In Sections 3, 4, 5 and 6 we deal with the jumping problem by means of the variational theorems of Section 2. In Section 3 we introduce the problem and some notations and recall some known results. In Sections 4, 5 and 6 we prove the existence of a certain number of solutions, in dependence on some parameters of the problem.

A synthesis with no proofs of the main results of this paper has been exposed in [38].

We conclude with some comments about the genesis of the variational theorems of mixed type, which we feel are necessary to fully understand the nature of the jumping problem. The lemmas of Section 2 are, in some sense, a re-interpretation and an extension in a non constrained setting of the techniques used in [30] for a bifurcation problem, where a functional constrained on a hypersurface was involved. These methods were also used and reformulated in [8]. The key fact in these results lies in the topological theorems contained in [12] (see Theorem 2.2).

In particular the abstract Lemma 2.3 originated from a conjecture of M. Degiovanni, which turned out to be well fit to treat our problem.

2. – Some abstract variational theorems

In this section we wish to expose the variational theorems we are going to use for proving the multiplicity results of Sections 4, 5 and 6. These theorems are essentially based on the general Statement 2.2. First we need some definitions.

DEFINITION 2.1. Let H be a Hilbert space, M a C^1 manifold with boundary in H , which is assumed, for sake of simplicity, to be the closure of an open subset of H . Let $g : M \rightarrow \mathbb{R}$ be a C^1 function. If $u \in \partial M$, we denote by $\nu(u)$ the unit normal to M at u pointing outwards and we define the lower gradient of g at u , by

$$\text{grad}^- g(u) = \begin{cases} \text{grad } g(u) & \text{if } u \in \text{int}(M) \\ \text{grad } g(u) + \langle \text{grad } g(u), \nu(u) \rangle^- \nu(u) & \text{if } u \in \partial M. \end{cases}$$

We say that u is a lower critical point for g if $\text{grad}^- g(u) = 0$.

Let $c \in \mathbb{R}$; we say that c is a critical value for g , if there exist a lower critical point u such that $g(u) = c$; we say that c is a regular value for g if c is not critical.

Moreover we say that the Palais-Smale condition holds at level c (briefly (P.S.) $_c$ holds), if

$$(2.1.1) \quad \begin{cases} \text{for any } (u_n)_n \text{ with } \lim_{n \rightarrow \infty} g(u_n) = c \text{ and } \lim_{n \rightarrow \infty} \text{grad}^- g(u_n) = 0 \\ \text{there exists a subsequence of } (u_n)_n \text{ which converges.} \end{cases}$$

THEOREM 2.2. *Let H be a Hilbert space, M a $C^{1,1}$ manifold with boundary in H , which is assumed, for sake of simplicity, to be the closure of an open subset of H . Let $g : M \rightarrow \mathbb{R}$ be a $C^{1,1}$ function. Finally let a, b be real numbers such that $a < b$, a and b are regular values for g . Assume that there exist p, q in \mathbb{N} , with $p \geq 1, q \geq 1, \tau_1$ in $H_p(g^b, g^a), \tau_2$ in $H_{p+q}(g^b, g^a)$ and ω in $H^q(g^b)$ such that $\tau_1 \neq 0, \tau_2 \neq 0$ and $\tau_1 = \tau_2 \cap \omega$.*

Moreover assume that the (P.S.) $_c$ condition holds for g at every c in $[a, b]$. Then there exist at least two lower critical points for g in $g^{-1}([a, b])$.

The proof of this result can be easily obtained from Theorem 3.5 of Chapter II of [12], making simple adaptations to take into account the presence of the boundary ∂M (see e.g. [42]; [12] also provides a plenty of other multiplicity results and references).

Now we introduce some notations we are going to use throughout this whole section. We shall consider a Hilbert space H , whose inner product and norm will be denoted by $\langle \cdot, \cdot \rangle$ and $\|\cdot\|$ respectively, and three subspaces X_1, X_2 and X_3 of H such that $H = X_1 \oplus X_2 \oplus X_3, 0 < \dim(X_1) = n < \infty, 0 < \dim(X_2) = m < \infty$. We shall denote by $P_i : H \rightarrow X_i, i = 1, 2, 3$ the projections relative to the given decomposition of H .

Furthermore for R in $\mathbb{R}, i, j = 1, 2, 3$ let

$$\begin{aligned} B_i(R) &= \{u \in X_i \mid \|u\| < R\} & S_i(R) &= \{u \in X_i \mid \|u\| = R\} \\ B_{ij}(R) &= \{u \in X_i \oplus X_j \mid \|u\| < R\} & S_{ij}(R) &= \{u \in X_i \oplus X_j \mid \|u\| = R\} \end{aligned}$$

We recall that, if $f : H \rightarrow \mathbb{R}$ is a C^1 function and c is a real number, the (P.S.) $_c$ condition reduces to

$$(P.C.)_c \quad \begin{cases} \text{for any } (u_n)_n \text{ with } \lim_{n \rightarrow \infty} f(u_n) = c \text{ and } \lim_{n \rightarrow \infty} \text{grad} f(u_n) = 0 \\ \text{there exists a subsequence of } (u_n)_n \text{ which converges.} \end{cases}$$

We also denote by B^k and S^k the k -dimensional ball and the k -dimensional sphere respectively, k being an assigned integer.

Theorems 2.3, 2.5, 2.6 and 2.8 which follow will be used in Sections 4 and 6.

LEMMA 2.3. *Let $\gamma > 0$, set*

$$C_\gamma = \{u \in H \mid \|P_2 u\| \geq \gamma\}$$

and let $g : C_\gamma \rightarrow \mathbb{R}$ be a $C^{1,1}$ function such that the following assumptions are satisfied:

$$a' = \sup g (S_{12}(\rho) \cap \partial C_\gamma) < \inf g (B_{23}(R) \cap C_\gamma) = a''$$

$$b' = \sup g (S_{12}(\rho) \cap C_\gamma) < \inf g (S_{23}(R) \cap C_\gamma) = b''$$

for suitable ρ and R with $0 < \rho < R \leq +\infty$; in the case $R = +\infty$ the second inequality disappears.

Let $a \in]a', a''[$, $b \in]b', b''[$ and suppose that the $(P.S.)_c$ condition is satisfied at any c in $[a, b]$.

Then there exist two lower critical points for g in $g^{-1}([a, b])$.

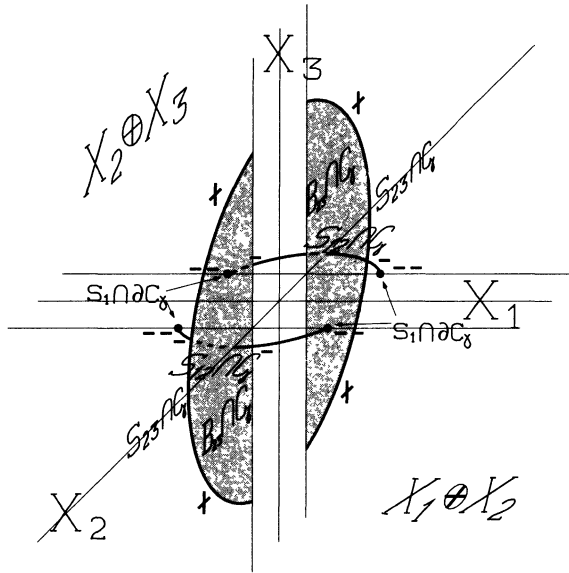

Fig. 1. The topological situation of Lemma 2.3

PROOF. Up to taking a slightly bigger a and a slightly smaller b we can suppose a and b to be regular values. We can also notice that in the case $m = 1$, C_γ has two connected components and in each one the “splitting spheres” principle (see Theorem 8.1 in [34]) can be applied; therefore we can limit ourselves to the case $m \geq 2$.

From the inequalities in the assumptions we obtain the following inclusions of topological pairs.

$$(S_{12}(\rho) \cap C_\gamma, S_{12}(\rho) \cap \partial C_\gamma) \stackrel{i}{\subset} (g^b, g^a) \stackrel{j}{\subset} (C_\gamma \setminus S_{23}(R), C_\gamma \setminus \overline{B}_{23}(R)) .$$

Now let $Z = C_\gamma \setminus (B_{23}(R) \times X_1) \cup S_{23}(R)$, it is clear that Z is closed in $C_\gamma \setminus S_{23}(R)$, $Z \subset C_\gamma \setminus \overline{B}_{23}(R)$ and that $C_\gamma \setminus \overline{B}_{23}(R)$ is open in $C_\gamma \setminus S_{23}(R)$ so

that, by the excision property, the inclusion

$$((C_\gamma \setminus S_{23}(R)) \setminus Z, (C_\gamma \setminus \overline{B}_{23}(R)) \setminus Z) \xrightarrow{j_1} (C_\gamma \setminus S_{23}(R), C_\gamma \setminus \overline{B}_{23}(R))$$

generates an isomorphism $(j_1)_*$ in the relative homology groups. Furthermore it can be easily seen that

$S_{12}(\rho) \cap C_\gamma$ is a deformation retract of $C_\gamma \cap (B_{23}(R) \times X_1)$

$S_{12}(\rho) \cap \partial C_\gamma$ is a deformation retract of $C_\gamma \cap (B_{23}(R) \times X_1) \setminus \overline{B}_{23}(R)$

(one can consider an intermediate retract obtained intersecting everything with $X_1 \oplus X_2$).

Therefore also the inclusion

$$(S_{12}(\rho) \cap C_\gamma, S_{12}(\rho) \cap \partial C_\gamma) \xrightarrow{i_1} (C_\gamma \cap (B_{23}(R) \times X_1), C_\gamma \cap (B_{23}(R) \times X_1) \setminus \overline{B}_{23}(R))$$

induces an isomorphism $(i_1)_*$ in homology. Then $j_* \circ i_* = (j_1)_* \circ (i_1)_*$ is an isomorphism; in particular i_* is a monomorphism.

Now consider the two inclusions

$$S_{12}(\rho) \cap C_\gamma \xrightarrow{i'} g^b \xrightarrow{j'} C_\gamma.$$

Since $S_{12}(\rho) \cap C_\gamma$ is a deformation retract of C_γ , then $(j' \circ i')^*$ is an isomorphism in the absolute cohomology groups; in particular $(i')^*$ is an epimorphism.

Now $(S_{12}(\rho) \cap C_\gamma, S_{12}(\rho) \cap \partial C_\gamma)$ is homotopically equivalent to the pair $(B^n \times S^{m-1}, S^{n-1} \times S^{m-1})$. Hence (see e.g. [30] or [8]) we can find τ_1 in $H_n(S_{12}(\rho) \cap C_\gamma, S_{12}(\rho) \cap \partial C_\gamma)$, τ_2 in $H_{n+m-1}(S_{12}(\rho) \cap C_\gamma, S_{12}(\rho) \cap \partial C_\gamma)$ and ω in $H^{m-1}(S_{12}(\rho) \cap C_\gamma)$ such that $\tau_1 \neq 0$, $\tau_2 \neq 0$ and $\tau_1 = \tau_2 \cap \omega$.

Take $\tau'_1 = i_*(\tau_1)$ in $H_n(g^b, g^a)$, $\tau'_2 = i_*(\tau_2)$ in $H_{n+m-1}(g^b, g^a)$ and ω' in $H^{m-1}(g^b)$ such that $(i')^*(\omega') = \omega$. It follows $\tau'_1 \neq 0$, $\tau'_2 \neq 0$ and by the properties of the cap product

$$\tau'_2 \cap \omega' = i_*(\tau_2) \cap \omega' = i_*(\tau_2 \cap (i')^*(\omega')) = i_*(\tau_2 \cap \omega) = i_*(\tau_1) = \tau'_1$$

and the conclusion follows from Theorem 2.2. □

Now we can deduce from the previous lemma a two solutions theorem for a function f defined on the whole space H , not just on C_γ . To this aim we introduce an assumption on the gradient of f which permits to “simulate” the constraint C_γ allowing us to apply Lemma 2.3. Such an assumption was suggested by the features of the problem (P) studied in Sections 3-6.

DEFINITION 2.4. Let $f : H \rightarrow \mathbb{R}$ a C^1 function. Let X be a closed subspace of H , $a, b \in \mathbb{R} \cup \{-\infty, +\infty\}$; we say that f verifies the condition $(\nabla)(f, X, a, b)$ if

$$(\nabla)(f, X, a, b) \quad \left\{ \begin{array}{l} \text{there exists } \gamma > 0 \text{ such that} \\ \inf \{ \|P_X \text{ grad } f(u)\| \mid a \leq f(u) \leq b, \text{dist}(u, X) \leq \gamma \} > 0 \end{array} \right.$$

where $P_X : H \rightarrow X$ denotes the orthogonal projection of H onto X .

In some sense we are requiring that $f|_X$ has no critical points u such that $a \leq f(u) \leq b$, with “some uniformity”.

THEOREM 2.5 (unlinked spheres with mixed type assumptions). *Let $f : H \rightarrow \mathbb{R}$ be a $C^{1,1}$ function. Assume that there exist ρ, R such that $0 < \rho < R \leq +\infty$ and*

$$(2.5.1) \quad \begin{aligned} a' &= \sup f(S_1(\rho)) < \inf f(B_{23}(R)) = a'' \\ b' &= \sup f(S_{12}(\rho)) < \inf f(S_{23}(R)) = b'' \end{aligned}$$

(if $R = +\infty$, then the second inequality disappears).

Let a, b be such that $a' < a < a'', b' < b < b''$ and suppose that

(2.5.2) the assumption $(\nabla)(f, X_1 \oplus X_3, a, b)$ holds;

(2.5.3) the $(P.S.)_c$ condition holds at any c in $[a, b]$.

Then f has at least two critical points in $f^{-1}([a, b])$.

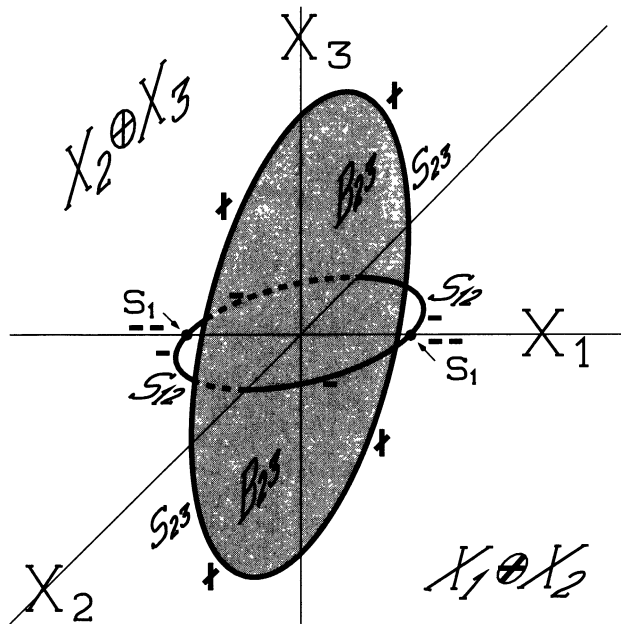

Fig. 2. The topological situation of Theorem 2.5.

PROOF. By $(\nabla)(f, X_1 \oplus X_3, a, b)$ there exists γ such that $\rho > \gamma > 0$ and, setting $C_\gamma = \{u \in H \mid \|P_2 u\| \geq \gamma\}$, $g = f|_{C_\gamma}$ has no lower critical points u with $u \in \partial C_\gamma$ and $a \leq f(u) \leq b$. It is easy to check that g verifies the two inequalities in the assumptions of Lemma 2.3; moreover using $(P.S.)_c$ for f and the condition (∇) it can be easily seen that $(P.S.)_c$ holds for g for all c in $[a, b]$. Then there exist two lower critical points u_1, u_2 for g in $g^{-1}([a, b])$. Since $u_1, u_2 \in \text{int}(C_\gamma)$, then u_1, u_2 are critical points for f . \square

Using the previous theorem and a standard saddle argument (see e.g. [44]) one can easily prove the following three critical points theorem, where the functional exhibits two “saddles in dimensional scale”, with the additional assumption on the gradient.

THEOREM 2.6 (two saddles in dimensional scale with mixed type assumptions). *Let $f : H \rightarrow \mathbb{R}$ be a $C^{1,1}$ function. Assume that there exists $\rho > 0$ such that*

$$(2.6.1) \quad \begin{aligned} a' &= \sup f(S_1(\rho)) < \inf f(X_2 \oplus X_3) = a'' \\ b' &= \sup f(S_{12}(\rho)) < \inf f(X_3) = b'' . \end{aligned}$$

Let a, b be such that $a' < a < a''$, $b' < b < b''$ and let $b_1 = \sup f(B_{12}(\rho))$. Suppose that

$$(2.6.2) \quad \text{the assumption } (\nabla)(f, X_1 \oplus X_3, a, b) \text{ holds ,}$$

$$(2.6.3.) \quad \text{the (P.S.)}_c \text{ condition holds at any } c \text{ in } [a, b_1]$$

Then f has at least two critical points in $f^{-1}([a, b])$ and another one in $f^{-1}([b', b_1])$.

It is clear that Theorem 2.6 can be easily adapted to the case of $k (\geq 2)$ saddles in dimensional scale.

REMARK 2.7. In 2.6, let us drop the assumption $(\nabla)(f, X_1 \oplus X_3, a, b)$. Then:

- 1) there exist two critical levels, one in $[a, b]$ and one in $[b'', b_1]$ (cfr. [9] where an interesting example is shown of a functional f (defined on a sphere) which has only a critical point in a given strip $f^{-1}([a, b])$ even though there are two nontrivial groups in $H_*(f^b, f^a)$);
- 2) if we assume the critical points of f to be nondegenerate, then the critical points with value in $[a, b]$ are at least two.

PROOF. The classical saddle argument yields the existence of a critical level in $[b'', b_1]$. Consider the inclusion $i : (S_{12}(\rho), S_1(\rho)) \rightarrow (f^b, f^a)$, then $i_* : H_*(S_{12}(\rho), S_1(\rho)) \rightarrow H_*(f^b, f^a)$ is a monomorphism, hence 1) holds because $H_*(f^b, f^a)$ is non trivial. Moreover

$$\sum_{q \geq 0} \dim(H_q(S_{12}(\rho), S_1(\rho))) = 2$$

which implies 2), using for instance the Morse Inequalities. □

We also notice that the following generalization of Theorem 2.6 holds.

THEOREM 2.8. *Let $f : H \rightarrow \mathbb{R}$ be a $C^{1,1}$ function. Assume that there exist $\rho, \rho', \rho'', \rho_1$ such that $0 < \rho_1 \leq +\infty, 0 \leq \rho' < \rho < \rho'' \leq +\infty$ and, setting*

$$\Delta = \{u \in X_2 \oplus X_3 \mid \rho' \leq \|P_2u\| \leq \rho'', \|P_3u\| \leq \rho_1\}, \quad T = \partial_{X_2 \oplus X_3} \Delta,$$

the following inequalities are fulfilled

$$(2.8.1) \quad \begin{aligned} a' &= \sup f(S_1(\rho)) < \inf f(\Delta) = a'' \\ b' &= \sup f(S_{12}(\rho)) < \inf f(T) = b'' \end{aligned}$$

Let a, b be such that $a' < a < a'', b' < b < b''$ and let $b_1 = \sup f(B_{12}(\rho))$. Assume that

$$(2.8.2) \quad \text{the assumption } (\nabla)(f, X_1 \oplus X_3, a, b) \text{ holds,}$$

$$(2.8.3) \quad \text{the (P.S.)}_c \text{ condition holds at any } c \text{ in } [a, b_1].$$

Then f has at least two critical points in $f^{-1}([a, b])$ and another one in $f^{-1}([b'', b_1])$.

SKETCH OF THE PROOF. The existence of two critical points with level between a and b can be obtained with a slight modification of the proof of Lemma 2.3. The existence of a critical level between b'' and b_1 can be deduced by standard linking arguments. \square

Notice that, surprisingly, if the dimension of H is finite, using Theorem 2.10 which follows, the assumption $\sup f(S_1(\rho)) < \inf f(\Delta)$ is not necessary, at least when ρ_1 and ρ'' are finite.

We now consider a dual version (in some sense) of the previous statements, which will be used in Sections 5 and 6.

LEMMA 2.9. *As above, let $\gamma > 0$,*

$$C_\gamma = \{u \in H \mid \|P_2u\| \geq \gamma\}.$$

$g : C_\gamma \rightarrow \mathbb{R}$ be a $C^{1,1}$ function. Let $\rho, \rho', \rho'', \rho_1$ be real numbers with $0 < \rho_1, 0 \leq \rho' < \rho < \rho''$ and define:

$$\Delta = \{u \in X_1 \oplus X_2 \mid \rho' \leq \|P_2u\| \leq \rho'', \|P_1u\| \leq \rho_1\} \quad T = \partial_{X_1 \oplus X_2} \Delta.$$

Assume that

$$a' = \sup g(T) < \inf g(S_{23}(\rho) \cap C_\gamma) = a''.$$

Let $a \in]a', a''[, b > \sup g(\Delta)$ and suppose that the (P.S.)_c condition is satisfied at any c in $[a, b]$.

Then there exist at least two lower critical points for g in $g^{-1}([a, b])$.

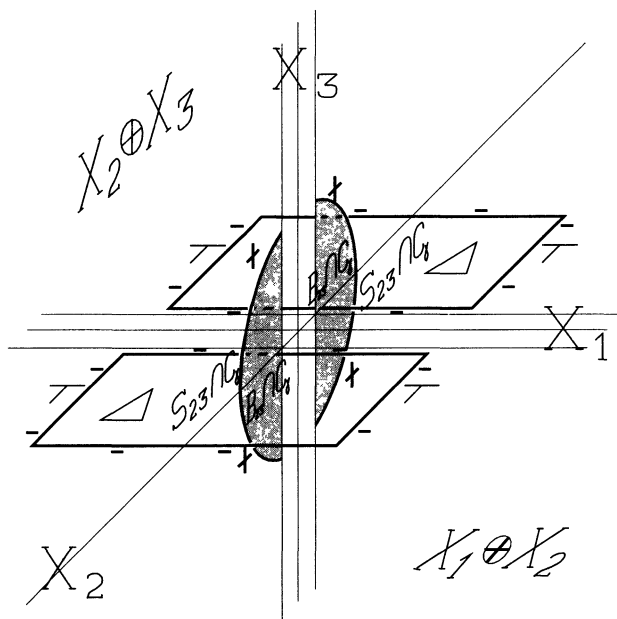

Fig. 3. The topological situation of Lemma 2.9

PROOF. Up to taking a slightly bigger a and a slightly smaller b we can suppose a and b to be regular values. If $m = 1$, C_γ has two connected components and in each one there is a critical point, obtained by saddle-like (or linking) arguments; so we deal with $m \geq 2$.

We have the following inclusions of topological pairs:

$$(\Delta, T) \overset{i}{\subset} (g^b, g^a) \overset{j}{\subset} (C_\gamma, C_\gamma \setminus S_{23}(\rho))$$

and it is not difficult to check that Δ is a deformation retract of C_γ and T is a deformation retract of $C_\gamma \setminus S_{23}(\rho)$. Then $j_* \circ i_*$ is an isomorphism in the relative homology groups and $i^* \circ j^*$ is an isomorphism in the absolute cohomology groups. In particular i_* is a monomorphism and i^* is an epimorphism.

Furthermore, since Δ is homeomorphic to $B_1(\rho_1) \times S_2(1) \times [\rho', \rho'']$, it is easily seen that (Δ, T) is homeomorphic to $(B^{n+1} \times S^{m-1}, S^n \times S^{m-1})$. Now the proof can be carried over exactly as in Lemma 2.3. \square

THEOREM 2.10 (sphere-torus linking with mixed type assumptions). Let $f : H \rightarrow \mathbb{R}$ be a $C^{1,1}$ function. Let $\rho, \rho', \rho'', \rho_1$ be such that $0 < \rho_1, 0 \leq \rho' < \rho < \rho''$, Δ and T be defined as in Lemma 2.9 and assume that

$$(2.10.1) \quad a' = \sup f(T) < \inf f(S_{23}(\rho)) = a'' .$$

Let a, b be such that $a' < a < a'', b > \sup f(\Delta)$ and

$$(2.10.2) \quad \text{the assumption } (\nabla)(f, X_1 \oplus X_3, a, b) \text{ holds;}$$

$$(2.10.3) \quad \text{the (P.S.)}_c \text{ condition holds at any } c \text{ in } [a, b] .$$

Then f has at least two critical points in $f^{-1}([a, b])$.

If furthermore

$$a_1 < \inf f(B_{23}(\rho)) > -\infty$$

and $(P.S.)_c$ holds at every c in $[a_1, b]$, then f has another critical level between a_1 and a' .

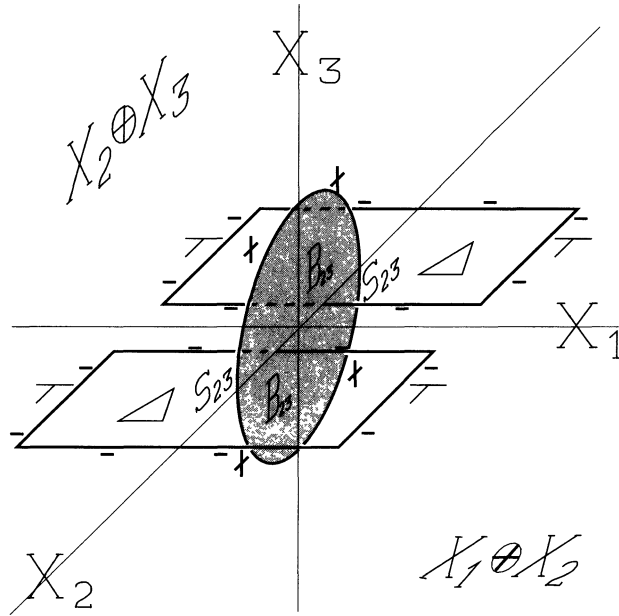

Fig. 4. The topological situation of Theorem 2.10

PROOF. It is clear that, up to small perturbations, ρ' can be taken strictly positive. By $(\nabla)(f, X_1 \oplus X_3, a, b)$ there exists γ such that $\rho > \gamma > 0$ and, setting $C_\gamma = \{u \in H \mid \|P_2(u)\| \geq \gamma\}$, there exist no lower critical points u for $g = f|_{C_\gamma}$ with $a \leq f(u) \leq b$. By Lemma 2.9, arguing as in the proof of Theorem 2.5, f has two critical points in $f^{-1}([a, b])$. For the third critical point a standard linking argument can be used. \square

The theorems we have exposed so far are sufficient for treating the problem of Sections 4, 5, 6; anyway it seems to us worth noting that using almost the same assumptions of Lemma 2.9, additional solutions can be found. Unfortunately it was not possible to apply this result to the jumping problem of 3-6.

LEMMA 2.11. Let $\gamma, \rho, \rho_1, \rho', \rho'', C_\gamma$ and T be as in Lemma 2.9. Assume that

$$b' = \sup g(T) < \inf g(S_{23}(\rho) \cap C_\gamma) = b''$$

$$\inf(B_{23}(\rho) \cap C_\gamma) > -\infty.$$

Let $b \in]b', b''[$, $a < \inf g(B_{23}(\rho) \cap C_\gamma)$ and suppose that the (P.S.)_c condition is satisfied at any c in $[a, b]$.

Then there exist at least two lower critical points for g in $g^{-1}([a, b])$.

As a consequence, if the (P.S.)_c condition holds also at every c in $[a_1, b_1]$, where

$$b_1 > \sup g(\Delta), \quad b < a_1 < \inf g(S_{23} \cap C_\gamma),$$

then g has four distinct lower critical points, two of which are in $g^{-1}([a, b])$ and two in $g^{-1}([a_1, b_1])$.

SKETCH OF THE PROOF. We consider the two inclusions of topological pairs

$$(T, \emptyset) \xrightarrow{j_1^1} (T, T \setminus S_2(\rho)) \xrightarrow{j_2^1} (C_\gamma \setminus S_{23}(\rho), C_\gamma \setminus \overline{B}_{23}(\rho)).$$

Since $(T, T \setminus S_2(\rho))$ is a deformation retract of $C_\gamma \setminus S_{23}(\rho)$, $C_\gamma \setminus \overline{B}_{23}(\rho)$, j_1^* is an isomorphism. Notice that $(T, T \setminus S_2(\rho))$ is homeomorphic to the pair $(S^n \times S^{m-1}, \{p\} \times S^{m-1}) = (S^n, \{p\}) \times (S^{m-1}, \emptyset)$ (p any point in S^n); using Künneth's theorem and the properties of the cup product one finds that

$$H^q(T, T \setminus S_2(\rho), \mathbb{G}) = \begin{cases} \mathbb{G} & \text{if } q = n \text{ or } q = n + m - 1 \\ \{0\} & \text{otherwise} \end{cases}$$

(we are using the cohomology with coefficients in a field \mathbb{G}) and that there exist $\omega'_1 \in H^{m-1}(T, T \setminus S_2(\rho), \mathbb{G})$ and $\omega'_2 \in H^n(T, T \setminus S_2(\rho), \mathbb{G})$ such that $\omega'_2 \cup \omega'_1 \neq 0$. We set $\omega''_1 = (j_2^*)^{-1}(\omega'_1)$ and $\omega''_2 = (j_2^*)^{-1}(\omega'_2)$; it turns out that $j_2^*(\omega''_1 \cup \omega''_2) = j_2^*(\omega''_1) \cup (\omega''_2) = \omega'_1 \cup \omega'_2 \neq 0$, so $\omega''_1 \cup \omega''_2 \neq 0$.

Now we consider the inclusions

$$(T, \emptyset) \xrightarrow{i_1^1} (g^b, g^a) \xrightarrow{i_2^1} (C_\gamma \setminus S_{23}(\rho), C_\gamma \setminus \overline{B}_{23}(\rho)).$$

and define $\omega_1 = (i_2^*)(\omega''_1)$, $\omega_2 = (i_2^*)(\omega''_2)$. We have $\omega_1 \cup \omega_2 = i_2^*(\omega''_1 \cup \omega''_2)$, so $\omega_1 \cup \omega_2 \neq 0$ provided i_2^* is a monomorphism. For this it suffices to show that j_1^* is a monomorphism. Consider the following portion of the exact sequence of the pair $(T, T \setminus S_2(\rho))$

$$\begin{aligned} \dots \rightarrow H^{n+m-2}(T \setminus S_2(\rho)) \rightarrow H^{n+m-1}(T, T \setminus S_2(\rho)) \xrightarrow{j_1^*} \\ \xrightarrow{j_1^*} H^{n+m-1}(T) \rightarrow H^{n+m-1}(T \setminus S_2(\rho)) \rightarrow \dots \end{aligned}$$

Since $T \setminus S_2(\rho)$ is homeomorphic to S^{m-1} , when $n \neq 1$ the left end of the above sequence is trivial and j_1^* is a monomorphism. If $n = 1$, we find

$$H^m(T, T \setminus S_2(\rho)) \cong \mathbb{G} \xrightarrow{j_1^*} \mathbb{G} \rightarrow \{0\} \rightarrow \dots$$

So j_1^* is an epimorphism and since \mathbb{G} is a field, j_1^* is an isomorphism.

Using Theorem 1.1 in [12], we verify the assumptions of Theorem 2.2 and the conclusion follows. □

3. – The jumping problem

We consider a bounded open subset Ω of \mathbb{R}^N , $g : \Omega \times \mathbb{R} \rightarrow \mathbb{R}$ a Caratheodory function and two real numbers α, β . The following assumptions will be considered.

$$(g.\alpha.\beta) \quad \left\{ \begin{array}{l} \lim_{s \rightarrow +\infty} \frac{g(x, s)}{s} = \alpha \quad \text{for a.e. } x \text{ in } \Omega, \\ \lim_{s \rightarrow -\infty} \frac{g(x, s)}{s} = \beta \quad \text{for a.e. } x \text{ in } \Omega; \end{array} \right.$$

$$(g) \quad \left\{ \begin{array}{l} |g(x, s)| \leq a |s| + b(x) \quad \text{for a.e. } x \text{ in } \Omega \quad \forall s \text{ in } \mathbb{R} \\ \text{where } a \in \mathbb{R}, b \in L^2(\Omega); \end{array} \right.$$

and, setting $G(x, s) = \int_0^s g(x, \sigma) d\sigma$,

$$(P.S.g) \quad \left\{ \begin{array}{l} |2G(x, s) - g(x, s)s| \leq a_0(x) |s| + b_0(x) \\ \text{for all } s \text{ in } \mathbb{R} \text{ and a.e. } x \text{ in } \Omega, \text{ where } b_0 \in L^1(\Omega), \\ a_0 \in L^p(\Omega), p \geq \frac{2N}{N+2} \quad (p > 1, \text{ if } N = 2, p = 1, \text{ if } N = 1). \end{array} \right.$$

(it would be possible to use weaker one-side assumption: see (2.6) c) in [34], pg. 297). We point out that assumption (P.S.g) will be only used to derive the Palais–Smale condition for the functional involved in our problem.

We are interested in the number of solutions of the problem:

$$\left\{ \begin{array}{l} \Delta u + g(x, u) = h \quad \text{where } h \in L^2(\Omega) \\ u \in H_0^1(\Omega). \end{array} \right.$$

Actually, according with the asymptotical nature of our assumptions, we shall deal with:

$$(P_t) \quad \left\{ \begin{array}{l} \Delta u + g(x, u) = te_1 + h_0 \quad \text{where } t \gg 0, h_0 \in L^2(\Omega) \\ u \in H_0^1(\Omega) \end{array} \right.$$

e_1 being the first eigenfunction of $-\Delta$ in $H_0^1(\Omega)$, chosen is such a way that $e_1 > 0$ in Ω .

We recall that (P_t) is of variational type in the sense that its solutions are the critical points of the functional $f_t : H_0^1(\Omega) \rightarrow \mathbb{R}$ defined by

$$f_t(u) = \frac{1}{2} \int_{\Omega} |Du|^2 dx - \int_{\Omega} G(x, u) dx + \int_{\Omega} u(te_1 + h_0) dx$$

considering in $H_0^1(\Omega)$ the standard inner product $\langle u, v \rangle_{H_0^1(\Omega)} = \int_{\Omega} Du Dv dx$.

The problem (P_t) has been the object of several studies (see [34] for a brief survey) and several results have been proved relating the number of solutions to the position of the pair (α, β) with respect to the eigenvalues of $-\Delta$. Although these results are numerous and interesting the techniques used and the points of view adopted are often very different among them, even when using the variational approach.

In [34] some new results have been obtained and a unified approach has been proposed, for the case where both α and β are greater than λ_1 . A map has also been drawn, in which some regions of the (α, β) -plane are shown, corresponding to one, two, three and four solutions.

It is also useful to recall from [34] that, under the assumptions (g) , $(g.\alpha.\beta)$ and $(P.S.g)$, for t positive and large enough the functional f_t satisfies $(P.S.)_c$ for any c .

In the present paper we find some new three and five solutions regions which fill some “gap” in the previous map: see the new map in figure 5

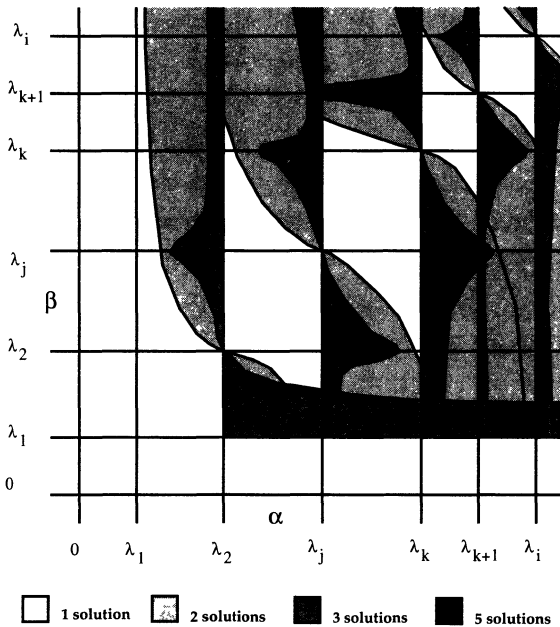

Fig. 5. Map of the results for $\alpha, \beta > \lambda_1$ (λ_i eigenvalues of $-\Delta$)

These results are obtained by the variational theorems of Section 2; notice that we need such theorems of mixed type to distinguish different critical points that may share the same level of the functional f_t . On the contrary in [34] more restrictions on the positions of (α, β) allowed to prove multiplicity results for the critical levels.

Even if our results concern problem (P_t) , from now on we consider the simplified problem

$$(P) \quad \begin{cases} \Delta u + \alpha u^+ - \beta u^- = e_1 \\ u \in H_0^1(\Omega) \end{cases}$$

whose solutions are the critical points of the functional $f : H_0^1(\Omega) \rightarrow \mathbb{R}$ defined by

$$f(u) = \frac{1}{2} \int_{\Omega} (|Du|^2 - \alpha(u^+)^2 - \beta(u^-)^2) dx + \int_{\Omega} u e_1 dx.$$

Actually, if for some pair (α, β) f satisfies the assumptions of one of the abstract theorems of Section 2, so does f_t , for t positive and large enough. This is a consequence of Lemma 3.1, which we state now, and of the technical Lemma 4.4, to be found in Section 4.

LEMMA 3.1. *Let (g) , $(g.\alpha, \beta)$ and $(P.S.g)$ hold. Then for any $M > 0$*

$$(3.1.1) \quad \lim_{t \rightarrow \infty} \sup_{\|u\| \leq M} \left| \frac{f_t(tu)}{t^2} - f(u) \right| = 0$$

$$(3.1.2) \quad \lim_{t \rightarrow \infty} \sup_{\|u\| \leq M} \left\| \text{grad} \frac{f_t(tu)}{t^2} - \text{grad} f(u) \right\| = 0$$

We omit the proof which can be accomplished by standard arguments.

Now we introduce some notations and recall some fact that will be useful in what follows. For i in \mathbb{N} we denote by λ_i the i -th eigenvalue of $-\Delta$ in $H_0^1(\Omega)$ and by e_i the corresponding eigenfunction:

$$\Delta e_i + \lambda_i e_i = 0, \quad \int_{\Omega} e_i^2 dx = 1, \quad \lambda_1 < \lambda_2 \leq \lambda_3 \leq \dots$$

Furthermore we set

$$H_i = \text{span} \{e_1, \dots, e_i\}, \quad H_i^\perp = \{u \in H_0^1(\Omega) \mid \langle u, v \rangle_{H_0^1(\Omega)} = 0 \quad \forall v \in H_i\},$$

and if $u \in H_0^1(\Omega)$

$$(3.1.3) \quad Q_{\alpha, \beta}(u) = \frac{1}{2} \int_{\Omega} (|Du|^2 - \alpha(u^+)^2 - \beta(u^-)^2) dx,$$

$$(3.1.4) \quad Q_{\alpha}(u) = \frac{1}{2} \int_{\Omega} (|Du|^2 - \alpha u^2) dx.$$

If $\alpha > \lambda_1$, we denote by \bar{e}_1 the function $\frac{e_1}{\alpha - \lambda_1}$. We notice that \bar{e}_1 is a solution of (P) , as one can easily check. The solutions we are going to find “branch”

from \bar{e}_1 . This motivates the interest for the increment $f(\bar{e}_1 + z) - f(\bar{e}_1)$; with easy computation one finds:

$$\begin{aligned}
 (3.1.5) \quad f(\bar{e}_1 + z) - f(\bar{e}_1) &= Q_\alpha(z) + \frac{\alpha - \beta}{2} \int_\Omega ((\bar{e}_1 + z)^-)^2 dx \\
 &= Q_{\alpha,\beta}(z) + \frac{\alpha - \beta}{2} \int_\Omega \left(((\bar{e}_1 + z)^-)^2 - (z^-)^2 \right) dx.
 \end{aligned}$$

We conclude the section with a result about the $(P.S.)_c$ condition for f , whose proof can be easily done by imitating the proof of (2.5) in [34]

REMARK 3.2. Assume that $(\alpha, \beta) \neq (\lambda_i, \lambda_i)$ for all $i \geq 2$. Then f satisfies the $(P.S.)_c$ condition for any c in \mathbb{R} .

4. – Three solutions regions in the (α, β) plane with $\alpha > \beta$

In this section we study problem (P) in the case $\alpha > \beta$ and we individuate some three solution regions in the (α, β) -plane. We wish to point out that we are not making any assumptions on the multiplicity of the eigenvalues considered in the following theorems.

We introduce some additional notations to be maintained throughout this and the following sections. For i in \mathbb{N} we set

$$\mathbf{S}_i(\rho) = \{u \in H_i \mid \|u - \bar{e}_1\| = \rho\}, \quad \mathbf{B}_i(\rho) = \{u \in H_i \mid \|u - \bar{e}_1\| < \rho\}.$$

LEMMA 4.1. *Let j, k be integers such that $k > j \geq 1$ and $\lambda_j < \lambda_{j+1} = \lambda_k < \lambda_{k+1}$. Let $\epsilon > 0$ and $M \geq \epsilon$. There exist $\sigma > 0, \rho_j$ with $\rho_j > 0$ such that for all α in $]\lambda_k, \lambda_k + \sigma[$ and for all β in $[\lambda_k - M, \lambda_k - \epsilon]$ there exists ρ_k with $\rho_j \geq \rho_k > 0$ such that the following inequalities hold.*

$$(4.1.1) \quad \sup f(\mathbf{S}_j(\rho_j)) < \inf f(\bar{e}_1 + H_j^\perp)$$

$$(4.1.2) \quad \sup f(\mathbf{S}_k(\rho_k)) < \inf f(\bar{e}_1 + H_k^\perp)$$

$$(4.1.3) \quad \sup f(\mathbf{S}_j(\rho)) < \inf f(\bar{e}_1 + H_k^\perp) \quad \forall \rho \text{ in } [\rho_k, \rho_j].$$

PROOF. Using the first equality in formula (3.1.5) one easily finds σ, ρ_j such that $\sigma > 0, \rho_j > 0$ and for every α in $[\lambda_k, \lambda_k + \sigma]$, for every β in $[\lambda_k - M, \lambda_k - \epsilon]$ and for every ρ in $]0, \rho_j]$

$$\sup f(\mathbf{S}_j(\rho)) < f(\bar{e}_1).$$

If $\lambda_k + \sigma < \lambda_{k+1}$ then $\alpha, \beta \leq \lambda_{k+1}$ and we have $\inf f(\bar{e}_1 + H_k^\perp) = f(\bar{e}_1)$, therefore (4.1.3) holds, for any ρ in $]0, \rho_j]$.

Now notice that taking $\alpha = \lambda_k$ and $\beta < \alpha$ one has $\inf f(\bar{e}_1 + H_k^\perp) = f(\bar{e}_1)$ and then, using (6.2) and (7.1) of [34], for σ small enough (4.1.1) holds.

Finally, having fixed α in $]\lambda_k, \lambda_k + \sigma[$, using (3.1.5) again, we can find ρ_k such that (4.1.2) holds too. □

LEMMA 4.2. *Let $j, k \in \mathbb{N}$, $k > j \geq 1$ and $\lambda_j < \lambda_{j+1} = \lambda_k < \lambda_{k+1}$. Let $\delta > 0$, $M \geq 0$. There exists ϵ with $\epsilon > 0$ such that for all α in $[\lambda_j + \delta, \lambda_{k+1} - \delta]$, for all u in $H_j \oplus H_k^\perp$ with $u \neq \bar{e}_1$ and*

$$\begin{aligned} \text{either} & & -M \leq \beta \leq \alpha \text{ and } f(u) \geq f(\bar{e}_1) - \epsilon \\ \text{or} & & M \geq \beta \geq \alpha \text{ and } f(u) \leq f(\bar{e}_1) + \epsilon, \end{aligned}$$

u cannot be a critical point for f on $H_j \oplus H_k^\perp$.

PROOF. We argue by contradiction and suppose that there exists $u = \bar{e}_1 + z$ with $z \in H_j \oplus H_k^\perp$ such that $z \neq 0$ and $f'(u)(v) = 0$ for all v in $H_j \oplus H_k^\perp$. This implies

$$(4.2.1) \quad Q'_\alpha(z)(v) - (\alpha - \beta) \int_\Omega (\bar{e}_1 + z)^- v \, dx = 0 \quad \forall v \in H_j \oplus H_k^\perp.$$

Let $z = z' + z''$ with z' in H_j and z'' in H_k^\perp ; taking $v = z'' - z'$ in (4.2.1) yields

$$2 [Q_\alpha(z'') - Q_\alpha(z')] - (\alpha - \beta) \int_\Omega (\bar{e}_1 + z)^- (z'' - z') \, dx.$$

It follows

$$(4.2.2) \quad \|z\|_{H_0^1(\Omega)} \leq \frac{|\alpha - \beta|}{C\sqrt{\lambda_1}} \|(\bar{e}_1 + z)^-\|_{L^2(\Omega)}$$

where $C = \frac{\delta}{\lambda_{k+1}} = \min \left\{ 1 - \frac{\alpha}{\lambda_{k+1}}, \frac{\alpha}{\lambda_j} - 1 \right\}$. Since the right hand side of (4.2.2) is $o(\|z\|_{H_0^1(\Omega)})$, we can find R with $R > 0$ and such that $\|z\|_{H_0^1(\Omega)} \geq R$; such an R only depends on δ and M (since so does the estimate (4.2.2)).

We claim that there exists $R_1 > 0$, only depending on δ and M , such that $|\alpha - \beta| \int_\Omega (\bar{e}_1 + z)^- \bar{e}_1 \, dx \geq R_1$. By contradiction let $(z_n)_n$ be a sequence in $H_j \oplus H_k^\perp$ such that $\|z_n\|_{H_0^1(\Omega)} \geq R$ and $|\alpha - \beta| \int_\Omega (\bar{e}_1 + z_n)^- \bar{e}_1 \, dx \rightarrow 0$. Set

$$w_n = \frac{(\alpha - \beta)(\bar{e}_1 + z_n)^-}{\|z_n\|_{H_0^1(\Omega)}},$$

then $(w_n)_n$ is bounded in $H_0^1(\Omega)$, hence relatively compact

in $L^2(\Omega)$. We can suppose $w_n \rightarrow w$ in $L^2(\Omega)$. Then $w \geq 0$, since $w_n \geq 0$; moreover $\int_\Omega w \bar{e}_1 \, dx = \lim_{n \rightarrow \infty} \int_\Omega w_n \bar{e}_1 \, dx = 0$ which implies $w = 0$. But, using (4.2.2) again yields

$$c\sqrt{\lambda_1} \leq \|w_n\|_{L^2(\Omega)}$$

which is impossible.

Now taking $v = z$ in (4.2.1) gives

$$(4.2.3) \quad \begin{aligned} 0 &= 2Q_\alpha(z) - (\alpha - \beta) \int_\Omega (\bar{e}_1 + z)^- z \, dx \\ &= 2(f(\bar{e}_1 + z) - f(\bar{e}_1)) + (\alpha - \beta) \int_\Omega (\bar{e}_1 + z)^- \bar{e}_1 \, dx \end{aligned}$$

This gives the conclusion, taking $\epsilon < \frac{R_1}{2}$. □

LEMMA 4.3. Let $j, k \in \mathbb{N}$ with $1 \leq j \leq k$, $(\alpha, \beta) \in \mathbb{R}^2$, $(\alpha, \beta) \neq (\lambda_i, \lambda_i)$ for all i with $2 \leq i \leq j$ or $i \geq k + 1$. Denote by P', P'' the projections of $H_0^1(\Omega)$ on $\text{span}\{e_{j+1}, \dots, e_k\}$ and on $H_j \oplus H_k^\perp$.

If a sequence $(u_n)_n$ has the properties

$$(4.3.1) \quad f(u_n) \text{ is bounded, } \lim_{n \rightarrow \infty} P'' \text{ grad } f(u_n) = 0, \quad \lim_{n \rightarrow \infty} P' u_n = 0,$$

then $(u_n)_n$ is bounded. •

PROOF. Assume by contradiction that there exists a sequence $(u_n)_n$ satisfying (4.3.1) and with $\|u_n\|_{H_0^1(\Omega)} \rightarrow \infty$. Set $z_n = \frac{u_n}{\|u_n\|_{H_0^1(\Omega)}}$. Since $\text{grad } f(u) = u + \Delta^{-1}(\alpha u^+ - \beta u^- - e_1)$ we have

$$(4.3.2) \quad \begin{aligned} P''(\text{grad } f(u_n)) &= u_n - P'(u_n) + P''(\Delta^{-1}(\alpha u^+ - \beta u^- - e_1)) \\ &= u_n - K(u_n, e_1) \rightarrow 0 \end{aligned}$$

where $K : H_0^1(\Omega) \times H_0^1(\Omega) \rightarrow H_0^1(\Omega)$ is a compact operator.

Then $z_n - K(z_n, \frac{e_1}{\|u_n\|_{H_0^1(\Omega)}}) \rightarrow 0$, which implies (up to subsequences) that $(z_n)_n$ converges to a point z in $H_0^1(\Omega)$; z has the properties

$$\|z\|_{H_0^1(\Omega)} = 1, \quad z \in H_j \oplus H_k^\perp, \quad \Delta z + P'(\alpha z^+ + \beta z^-) = 0.$$

In particular, multiplying by e_1 and integrating over Ω , we obtain

$$(4.3.3) \quad \alpha \int_{\Omega} e_1 z^+ dx = \beta \int_{\Omega} e_1 z^- dx.$$

Multiplying by $P''(u_n)$ in (4.3.2), integrating over Ω and dividing by $\|u_n\|$ yields

$$\begin{aligned} \frac{2f(u_n)}{\|u_n\|_{H_0^1(\Omega)}} &= \int_{\Omega} e_1 z_n dx + \langle P''(\text{grad } f(u_n)), z_n \rangle \\ &+ \int_{\Omega} D z_n D P'(u_n) - P'(\alpha z_n^+ - \beta z_n^-) + \frac{e_1}{\|u_n\|_{H_0^1(\Omega)}} P'(u_n) dx. \end{aligned}$$

It follows $\int_{\Omega} e_1 z dx = 0$. If $\alpha \neq \beta$ this fact, combined with (4.3.3) implies that $z^+ = z^- = 0$ which is contradictory.

If $\alpha = \beta = \lambda$, then z must be an eigenvector of $-P'' \circ \Delta$ with λ as eigenvalue. So $\lambda = \lambda_i$ with i not in $\{j + 1, \dots, k\}$ and moreover $i \neq 1$ because $\int_{\Omega} e_1 z dx = 0$. This concludes the proof. □

As claimed in Section 3, the results proved for the “simplified” functional f also hold for the functional f_t , for t positive and large enough. To treat this case it is necessary to use Lemma 3.1 and a more general version of Lemma 4.3, which we state now. The proof is omitted since it is very similar to that of 4.3.

LEMMA 4.4. Let $j, k \in \mathbb{N}$ with $1 \leq j \leq k$, $(\alpha, \beta) \in \mathbb{R}^2$, $(\alpha, \beta) \neq (\lambda_i, \lambda_i)$ for all i with $2 \leq i \leq j$ or $i \geq k + 1$. Let P', P'' be as in Lemma 4.3. Assume that (g) , $(g.\alpha.\beta)$ and $(P.S.g)$ hold.

Let $(u_n)_n$ in $H_0^1(\Omega)$, $(t_n)_n$ in \mathbb{R} and $((\alpha_n, \beta_n))_{n \in \mathbb{N}}$ in \mathbb{R}^2 be sequences such that

$$\lim_{n \rightarrow \infty} t_n = +\infty, \quad \lim_{n \rightarrow \infty} (\alpha_n, \beta_n) = (\alpha, \beta)$$

$$f_{t_n}(u_n) \text{ is bounded, } \quad \lim_{n \rightarrow \infty} P'' \text{ grad } f_{t_n}(u_n) = 0, \quad \lim_{n \rightarrow \infty} P' u_n = 0,$$

then $(u_n)_n$ is bounded.

THEOREM 4.5. Let $k \geq 2$. There exists an open neighbourhood U of the half-line $\{(\lambda_k, \beta) \in \mathbb{R}^2 \mid \beta < \lambda_k\}$ such that, if $W_k = \{(\alpha, \beta) \in U \mid \alpha > \lambda_k\}$, then for all (α, β) in W_k problem (P) has at least 3 solutions u_1, u_2, u_3 , f has at least two critical levels. Moreover if j is such that $\lambda_j < \lambda_{j+1} = \lambda_k$, then $f(u_i) \geq \inf f(\bar{e}_1 \oplus H_j^\perp)$ $i = 1, 2, 3$.

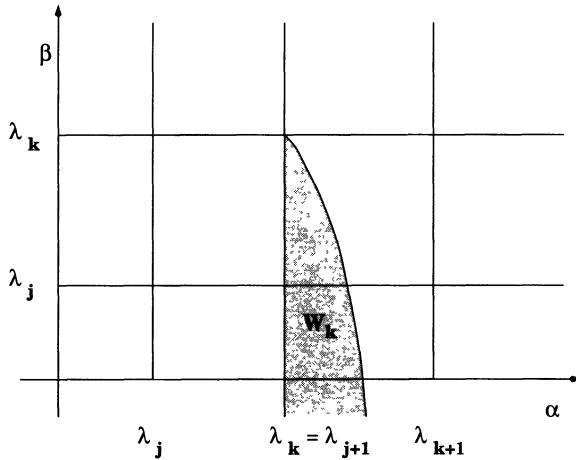

Fig. 6. The three solution region of Theorem 4.5

PROOF. We wish to apply Theorem 2.6. We can suppose that $\lambda_k < \lambda_{k+1}$ and take j with $j < k$, $\lambda_j < \lambda_{j+1} = \lambda_k$. Now let δ, M be strictly positive and let ϵ be such that the conclusion of Lemma 4.2 holds. Let $W_k^{(M,\delta)}$ be the set of all pairs (α, β) such that

$$\lambda_k < \alpha < \lambda_{k+1} - \delta, \quad -M < \beta < \alpha$$

$$\inf f(\bar{e}_1 + H_j^\perp) > f(\bar{e}_1) - \epsilon$$

there exist ρ_j, ρ_k such that $\rho_j \geq \rho_k > 0$ and (4.1.1), (4.1.2), (4.1.3) hold.

Notice that $W_k^{(M,\delta)}$ is an open set, as a consequence of Lemma 7.1 in [34] and $W_k^{(M,\delta)}$ is nonempty by Lemma 4.1. If $(\alpha, \beta) \in W_k^{(M,\delta)}$, the inequalities (2.6.1)

of Theorem 2.6 hold, up to modifying the set $S_k(\rho_k) \cup \overline{(\mathbf{B}_j(\rho_j))} \setminus \mathbf{B}_j(\rho_k)$ into the set

$$\tilde{S}_k = \{u \in H_k \mid \text{dist}(u, \mathbf{B}_k(\rho_k) \cup \mathbf{B}_j(\rho_j)) = \gamma\}$$

(with $\gamma > 0$ small), which has the same topological properties of the sphere $S_{12}(\rho)$ in Theorem 2.6.

Concerning the (P.S.)_c condition, it suffices to use Remark 3.2.

Finally the assumption $(\nabla)(f, H_j \oplus H_k^\perp, a, b)$, where

$$\sup f(S_j(\rho_j)) < a < \inf f(\bar{e}_1 + H_j^\perp), \quad \sup f(\tilde{S}_k) < b < \inf f(\bar{e}_1 + H_k^\perp),$$

can be easily proved, in a standard fashion, using Lemmas 4.2 and 4.3. □

The next results provide some more details on the regions of the (α, β) plane, where three distinct solutions occur. To state such results we need the functions μ_k , introduced in [34], the functions ψ_j and the sets R_{jk} , we are going to define now.

DEFINITION 4.6. Let $j \in \mathbb{N}$, $j \geq 1$, $e \in H_0^1(\Omega)$, $e \neq 0$, $\alpha \in \mathbb{R}$. Define

$$\begin{aligned} \alpha_{j+1} &= \sup \left\{ \int_{\Omega} |Dv|^2 dx \mid v \in H_j, \int_{\Omega} v^2 dx = 1, v \geq 0 \right\} \\ \Sigma_j^-(e) &= \left\{ z = \sigma e + v \mid \sigma \geq 0, v \in H_j, \|z\|_{H_0^1(\Omega)} = 1 \right\} \\ \mu_{j+1}(\alpha) &= \inf \left\{ \beta \in \mathbb{R} \mid \exists e \in H_j^\perp \text{ with } e \neq 0, \max Q_{\alpha, \beta}(\Sigma_j^-(e)) < 0 \right\}. \end{aligned}$$

The following lemma is a consequence of (5.4) in [34].

PROPOSITION 4.7. Let $j \geq 1$. We have:

- 1) $\mu_{j+1}(\alpha) < +\infty \Leftrightarrow \alpha > \alpha_{j+1}$;
- 2) $\mu_{j+1}(\alpha) > \alpha_{j+1} \forall \alpha > \alpha_{j+1}$; the function $\mu_{j+1} :]\alpha_{j+1}, +\infty[\rightarrow]\alpha_{j+1}, +\infty[$ is continuous, decreasing, $\mu_{j+1} \circ \mu_{j+1} = \text{identity}$, $\mu_{j+1}(\lambda_{j+1}) = \lambda_{j+1}$ and

$$\lim_{\alpha \rightarrow \alpha_{j+1}} \mu_{j+1}(\alpha) = +\infty, \quad \lim_{\alpha \rightarrow +\infty} \mu_{j+1}(\alpha) = \alpha_{j+1};$$

- 3) if $j \geq 2$, then $\lambda_1 \leq \alpha_{j+1} < \lambda_j$; $\alpha_2 = \lambda_1$.

DEFINITION 4.8. Let $j \geq 1$, if $\alpha > \lambda_j$, $\beta > \lambda_j$, we define

$$\mathcal{M}_j(\alpha, \beta) = \left\{ u \in H_0^1(\Omega) \mid f'(u)(v) = 0 \quad \forall v \in H_j \right\}$$

(cfr. Theorem 9.2 in [34]).

For the proof of the following properties of $\mathcal{M}_j(\alpha, \beta)$ see (9.2) in [34]

PROPOSITION 4.9.

- 1) $\mathcal{M}_j(\alpha, \beta)$ is the graph of a Lipschitz continuous function $\Gamma_j : H_j^\perp \rightarrow H_j$; moreover for all v in H_j and all w in H_j^\perp $f(v + w) \leq f(\Gamma_j(w) + w)$;
- 2) if $\beta < \mu_{j+1}(\alpha)$, then

$$\lim_{\substack{\|u\| \rightarrow \infty \\ u \in \mathcal{M}_j(\alpha, \beta)}} f(u) = +\infty$$

(in particular f is bounded below on $\mathcal{M}_j(\alpha, \beta)$).

Now we introduce the functions ψ_j .

DEFINITION 4.10 Let $j \geq 1$ and $\alpha > \alpha_{j+1}$; we set

$$\psi_j(\alpha) = \inf \{ \beta \mid Q_{\alpha, \beta}(u) < 0 \quad \forall u \in H_j, u \neq 0 \} .$$

Notice that $\psi_1(\alpha) = \lambda_1$ for all $\alpha > \lambda_1 (= \alpha_2)$.

With some work one can prove the following properties.

PROPOSITION 4.11. Let $j \geq 2$; then

- 1) $\psi_j(\alpha) > \alpha_{j+1} \quad \forall \alpha > \alpha_{j+1}$, the function $\psi_j :]\alpha_{j+1}, +\infty[\rightarrow]\alpha_{j+1}, +\infty[$ is continuous, is decreasing, $\psi_j \circ \psi_j = \text{identity}$, $\psi_j(\lambda_j) = \lambda_j$ and

$$\lim_{\alpha \rightarrow \alpha_{j+1}} \psi_j(\alpha) = +\infty, \quad \lim_{\alpha \rightarrow +\infty} \psi_j(\alpha) = \alpha_{j+1};$$

- 2) $\psi_j(\alpha) \leq \mu_{j+1}(\alpha) \quad \forall \alpha > \alpha_{j+1}$; moreover if $\alpha \leq \alpha_{j+1}$ there are no β 's such that $Q_{\alpha, \beta}(u) < 0$ for all u in $H_j \setminus \{0\}$.

Now we are going to show that, if $\alpha > \lambda_{j+1}$, $\mu_{j+1}(\alpha) > \lambda_j$ and $\psi_j(\alpha) < \beta < \mu_{j+1}(\alpha)$, then a set of inequalities of the type of (2.6.1) and the gradient assumption of Definition 2.4 are fulfilled. For the latter we need to introduce the sets R_{jh} .

DEFINITION 4.12. Let $h \geq j \geq 1$. We set

$$R_{jh} = \{ (\alpha, \beta) \in \mathbb{R}^2 \mid \alpha > \lambda_1 ,$$

$$f|_{(H_j \oplus H_h^\perp)} \text{ has no critical points } u \text{ in } H_j \oplus H_h^\perp \text{ with } f(u) \neq f(\bar{e}_1) \}$$

PROPOSITION 4.13. Let $h \geq j \geq 1$. If $\alpha > \lambda_1$, $\lambda_j \leq \alpha \leq \lambda_{h+1}$, $\lambda_j \leq \beta \leq \lambda_{h+1}$, $(\alpha, \beta) \neq (\lambda_j, \lambda_j)$, $(\alpha, \beta) \neq (\lambda_{h+1}, \lambda_{h+1})$, then $(\alpha, \beta) \in R_{jh}$.

PROOF. Let $u = \bar{e}_1 + z$ be a critical point for $f|_{(H_j \oplus H_h^\perp)}$ ($z \in H_j \oplus H_h^\perp$).

Then

$$\int_{\Omega} (DuDv - \alpha u^+ v + \beta u^- v + e_1 v) dx = 0 \quad \forall v \in H_j \oplus H_h^\perp$$

$$\int_{\Omega} (D\bar{e}_1 Dv - \alpha \bar{e}_1 v + e_1 v) dx = 0 \quad \forall v \in H_0^1(\Omega)$$

(the second equality holds because \bar{e}_1 is critical). Taking the difference

$$(4.13.1) \quad \int_{\Omega} (DzDv - \chi(x, u)zv) dx = 0 \quad \forall v \in H_j \oplus H_h^\perp$$

where

$$\chi(x, s) = \begin{cases} \alpha & \text{if } s \geq 0, \\ \alpha \frac{-\bar{e}_1(x)}{s - \bar{e}_1(x)} + \beta \frac{s}{s - \bar{e}_1(x)} & \text{if } s \leq 0. \end{cases}$$

Notice that $\beta < \chi(x, s) \leq \alpha$ for all $(x, s) \in \Omega \times \mathbb{R}$. Now let $z = \eta + \theta$ with $\eta \in H_j$, $\theta \in H_h^\perp$. Using $v = \eta$ and $v = \theta$ in (4.13.1), and taking the difference yields:

$$0 \geq \int_{\Omega} (|D\eta|^2 - \chi(x, u)\eta^2) dx = \int_{\Omega} (|D\theta|^2 - \chi(x, u)\theta^2) dx \geq 0$$

hence

$$\begin{aligned} 0 &= \int_{\Omega} (|D\eta|^2 - \chi(x, u)\eta^2) dx \leq \int_{\Omega} (|D\eta|^2 - \lambda_j\eta^2) dx \leq 0 \\ 0 &= \int_{\Omega} (|D\theta|^2 - \chi(x, u)\theta^2) dx \geq \int_{\Omega} (|D\theta|^2 - \lambda_{k+1}\theta^2) dx \geq 0. \end{aligned}$$

If η is not identically zero, then η must be an eigenfunction of $-\Delta$ with eigenvalue λ_j , in particular $\eta(x) \neq 0$ for almost all x in Ω . This implies that $\chi(x, u(x)) = \lambda_j$ for almost every x . Then $\alpha = \lambda_j$ and $u \geq 0$, since $\beta \neq \alpha$ (just look at the expression of χ). From (4.13.1) it follows that z is an eigenfunction with eigenvalue λ_j . Then

$$f(u) = f(\bar{e}_1) + Q_{\lambda_j}(z) + \frac{\lambda_j - \beta}{2} \int_{\Omega} (u^-)^2 dx = f(\bar{e}_1).$$

Since $f(u) = f(\bar{e}_1)$ is excluded, $\eta = 0$.

In the same way, if θ is not identically zero, then it must be an eigenfunction of $-\Delta$ with λ_{h+1} as eigenvalue. Then, as before, $\lambda_{h+1} = \alpha$, and also $u \geq 0$, which implies

$$f(u) = f(\bar{e}_1) + Q_{\lambda_{h+1}}(z) + \frac{\lambda_{h+1} - \beta}{2} \int_{\Omega} (u^-)^2 dx = f(\bar{e}_1).$$

Then $\theta = \eta = 0$ and $u = \bar{e}_1$. So, in any case, $f(u)$ must be equal to $f(\bar{e}_1)$ and the proof is finished. \square

We can finally state another three solutions result.

LEMMA 4.14. *Let $j, h \in \mathbb{N}, h > j \geq 1$, and (α, β) be such that*

$$\begin{aligned} \lambda_h < \alpha \leq \lambda_{h+1}, \quad \mu_{j+1}(\alpha) > \lambda_j, \\ \psi_j(\alpha) < \beta < \mu_{j+1}(\alpha), \quad (\alpha, \beta) \in \mathcal{R}_{jh}. \end{aligned}$$

Then for all pairs (α', β') sufficiently near to (α, β) the corresponding functional f has at least three solutions.

PROOF. It is convenient, throughout the proof, to denote the functional by $f_{\alpha, \beta}$.

- 1) Since $\lambda_h < \alpha \leq \lambda_{h+1}$ and $\beta < \alpha$, there exists $\bar{\rho} > 0$ such that for all ρ in $]0, \bar{\rho}]$

$$\sup f_{\alpha, \beta}(\mathbf{S}_h(\rho)) < f_{\alpha, \beta}(\bar{e}_1) = \inf f_{\alpha, \beta}(\bar{e}_1 + H_h^\perp) = b''.$$

- 2) Let β_1 be such that $\beta \leq \beta_1, \lambda_j < \beta_1 < \mu_{j+1}(\alpha)$. Since $\alpha, \beta_1 > \lambda_j$, then $\mathcal{M}_j(\alpha, \beta_1)$ is well defined and since $\beta_1 < \mu_{j+1}(\alpha)$, then f_{α, β_1} is bounded below on $\mathcal{M}_j(\alpha, \beta_1)$. Being $f_{\alpha, \beta} \geq f_{\alpha, \beta_1}$

$$a'' = \inf f_{\alpha, \beta}(\mathcal{M}_j(\alpha, \beta_1)) > -\infty.$$

Notice that, if (α', β') is close to (α, β) , then the corresponding inf approaches a'' , because

$$\lim_{\substack{u \in \mathcal{M}_j(\alpha, \beta_1) \\ \|u\|_{H_0^1(\Omega)} \rightarrow \infty}} f_{\alpha, \beta}(u) = +\infty.$$

- 3) There exists $R \geq \rho$ such that

$$\begin{aligned} \sup_{u \in H_j} f_{\alpha, \beta}(\bar{e}_1 + u) < b'', \\ \rho \leq \|u\|_{H_0^1(\Omega)} \leq R \\ \sup f_{\alpha, \beta}(\mathbf{S}_j(R)) < a''. \end{aligned}$$

For this use the second equality in (3.1.5) and observe that the right hand side therein is the sum of two negative terms, since $Q_{\alpha, \beta}(u)$ is negative defined because $\psi_j(\alpha) < \beta$ and $\beta < \alpha$. It can be noticed again that all quantities involved in the inequalities have small variations when (α', β') is near (α, β) .

- 4) We claim now that a set of inequalities of the type of (2.6.1) hold. To show this we modify the set $\mathbf{S}_h(\rho) \cup (\overline{\mathbf{B}_j(R)} \setminus \mathbf{B}_j(\rho))$ into the (h -sphere like) set

$$\tilde{\mathbf{S}}_h = \{ \bar{e}_1 + v \mid v \in H_j, \text{dist}(v, \mathbf{S}_h(\rho) \cup \overline{\mathbf{B}_j(R)}) = \delta \}$$

where $\delta > 0$ is small enough so that

$$b' = \sup f_{\alpha,\beta}(\tilde{\mathbf{S}}_h) < b'' ,$$

$$a' = \sup f_{\alpha,\beta}(\tilde{\mathbf{S}}_h \cap H_j) < a'' .$$

Notice that $b'' = \inf \{ f_{\alpha,\beta}(w + \Gamma_j(w)) \mid w \in H_j \}$.

- 5) We can assume that there exist a, b, b_1 regular values for $f_{\alpha,\beta}$ such that $a \in]a', a''[$, $b \in]b', b''[$, $b_1 > \sup(f_{\alpha,\beta}(\mathbf{B}_h)) = b'''$.

Since there are no critical points u for $f \mid_{H_j \oplus H_h^\perp}$ with $f(u) \in [a, b]$, because $(\alpha, \beta) \in R_{jh}$ and $b < f_{\alpha,\beta}(\bar{e}_1)$, using Lemma 4.3, it can be easily deduced that condition $(\nabla)(f_{\alpha,\beta}, H_j \oplus H_h^\perp, a, b)$ holds.

From Theorem 2.6 we get the conclusion for the pair (α, β) .

- 6) Concerning the pairs (α', β') near (α, β) , first of all we notice that the numbers a', a'', b', b'' and b''' change a few, whenever (α, β) changes a few: in particular a'' changes slightly by 2 of Proposition 4.9 and b'' moves slightly by the results of [34]. Hence, if (α', β') is near to (α, β) , $a' < a < a''$, $b' < b < b''$ and $b_1 > b'''$, for the previously considered a, b and b_1 . Moreover using an argument analogous to Lemma 4.3, we obtain that $(\nabla)(f_{\alpha',\beta'}, H_j \oplus H_h^\perp, a, b)$ holds too.

So by Theorem 2.6 for $f_{\alpha',\beta'}$, we obtain the remaining part of the conclusion.

□

The following statement is a simple consequence of the previous lemma and of the properties of R_{jh} .

THEOREM 4.15. *Let $j \geq 2$. There exists an open neighbourhood U of the set*

$$\{(\alpha, \beta) \mid \lambda_{j+1} < \alpha, \lambda_j < \mu_{j+1}(\alpha), \lambda_j \leq \beta < \mu_{j+1}(\alpha)\}$$

such that for all (α, β) in U problem (P) has at least three solutions and the functional f has at least two critical values.

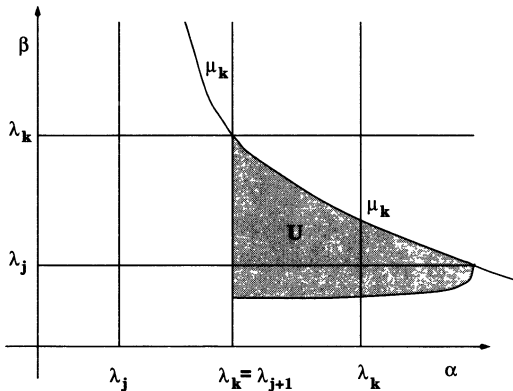

Fig. 7. The three solution region of Theorem 4.15.

REMARK 4.16. From the previous result the following known fact is easily deduced. Let $\alpha > \lambda_2, \lambda_1 < \beta < \mu_1(\alpha)$; then f has at least three critical points.

We conclude this section with a final remark. In the proof of Lemma 4.14 it is easily seen that the inequalities of the type of 2.6.1 are fulfilled without assuming that $(\alpha, \beta) \in R_{jh}$. Using Sard’s theorem we can find perturbations of f of the type $\tilde{f}(u) = f(u) + \int_{\Omega} v_0 u \, dx$ such that \tilde{f} has only nondegenerate critical points. On the other hand, by Remark 2.7 we obtain the following result.

REMARK 4.17. Let $j \geq 1, \alpha, \beta$ be such that $\alpha > \lambda_{j+1}, \mu_{j+1}(\alpha) > \lambda_j, \psi_j(\alpha) < \beta < \mu_{j+1}(\alpha)$. Then the functional \tilde{f} defined by

$$\tilde{f}(u) = f(u) + \int_{\Omega} v_0 u \, dx$$

has at least three critical points, provided v_0 is small enough and such that all its critical points are nondegenerate.

5. – Three solutions regions in the (α, β) plane with $\alpha < \beta$

When we pass to consider the (α, β) pairs with $\beta > \alpha$ we find a certain (unexpected) symmetry in the results. In fact we will use the abstract (“dual”) sphere-torus linking Theorem 2.10.

In this section we maintain all the notations of Section 4 and in addition, for i in \mathbb{N} and $\rho > 0$, we consider the sets

$$\begin{aligned} \mathbf{S}'_i(\rho) &= \left\{ \bar{e}_1 + w \mid w \in H_i^\perp, \|w\|_{H_0^1(\Omega)} = \rho \right\} \\ \mathbf{B}'_i(\rho) &= \left\{ \bar{e}_1 + w \mid w \in H_i^\perp, \|w\|_{H_0^1(\Omega)} < \rho \right\} \end{aligned}$$

LEMMA 5.1. *Let j, k be integers such that $k > j \geq 1$ and $\lambda_j < \lambda_{j+1} = \lambda_k < \lambda_{k+1}$. Assume that $\lambda_j \leq \alpha < \lambda_k, \alpha > \lambda_1$ and $\beta > \psi_k(\alpha) (> \alpha)$. Then there exist ρ and $\bar{\rho}$ such that $\bar{\rho} > \rho > 0$ and*

$$(5.1.1) \quad \sup f(\mathbf{B}_j(\bar{\rho}) \cup \mathbf{S}_k(\bar{\rho})) < \inf f(\mathbf{S}'_j(\rho))$$

PROOF. Since $\lambda_j \leq \alpha < \lambda_k$ and $\beta > \alpha$, using the formula (3.1.5) and the fact that the last term in (3.1.5) is positive and is $o(z)$, it turns out that there exist $\rho > 0$ such that

$$\sup f(H_j) = f(\bar{e}_1) < \inf f(\mathbf{S}'_j(\rho)).$$

Since $\beta > \psi_k(\alpha)$, we get

$$\lim_{\substack{\|u\| \rightarrow \infty \\ u \in H_k}} f(u) = -\infty,$$

hence for $\bar{\rho}$ large enough we have the conclusion. □

THEOREM 5.2. *Let $k \geq 2$. There exists an open neighbourhood of the half-line $\{(\lambda_k, \beta) \mid \beta > \lambda_k\}$ such that, if we call V_k its intersection with the set $\{(\alpha, \beta) \mid \alpha < \lambda_k\}$, then for every (α, β) in V_k there exist at least three solutions u_1, u_2, u_3 of problem (P) and f has at least two critical values; moreover $f(u_i) \leq \sup f(H_k)$, for $i = 1, 2, 3$.*

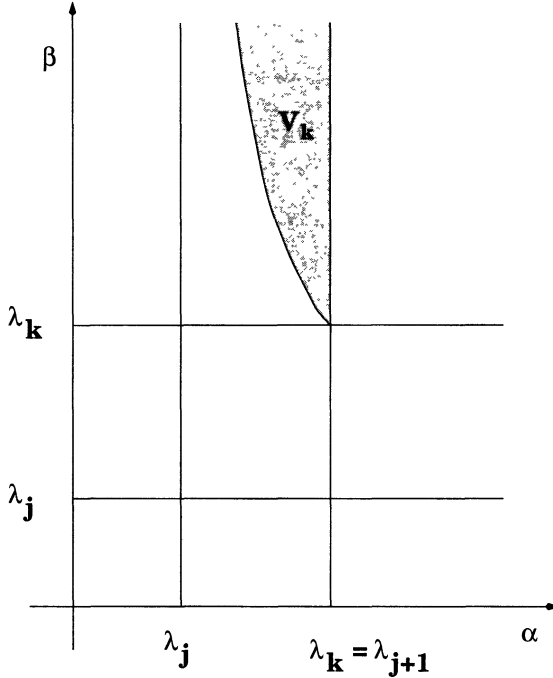

Fig. 8. The three solution region of Theorem 5.2.

PROOF. We can suppose that $\lambda_k < \lambda_{k+1}$ and choose j such that $j \geq 1$, $\lambda_j < \lambda_{j+1} = \lambda_k$. Let $\delta, M > 0$. Using Lemma 4.2 we can find ϵ with $\epsilon > 0$ and such that, if $\lambda_j + \delta \leq \alpha \leq \lambda_{k+1} - \delta$, $\alpha \leq \beta \leq M$, then $f|_{H_j \oplus H_k^\perp}$ has no critical points u with $u \neq \bar{e}_1$ and $f(u) \leq f(\bar{e}_1) + \epsilon$. Set

$$V_k^{(M, \delta)} = \{(\alpha, \beta) \mid \lambda_j + \delta < \alpha < \lambda_k, \psi_k(\alpha) < \beta < M, \sup f(H_k) < f(\bar{e}_1) + \epsilon\}.$$

The set $V_k^{(M, \delta)}$ is non empty and open because, if $\alpha = \lambda_k$ then $\sup f(H_k) = f(\bar{e}_1)$ and when $\psi_k(\alpha) < \beta$ we have $\lim_{\substack{\|u\| \rightarrow \infty \\ u \in H_k}} f(u) = -\infty$, so $\sup f(H_k)$

continuously depends on (α, β) (see Lemma 7.1 in [34]). Take (α, β) in $V_k^{(M, \delta)}$. By Lemma 5.1 there exist ρ and $\bar{\rho}$ such that $\bar{\rho} \geq \rho > 0$ and (5.1.1) holds. Up to slight modifications of $\mathbf{B}_j(\bar{\rho}) \cup \mathbf{S}_k(\bar{\rho})$, one can easily prove that (2.10.1) of Theorem 2.10 holds. Imitating the proof of Theorem 4.5 it can be checked, by Lemma 4.2.1, that condition $(\nabla)(f, H_j \oplus H_k^\perp, a, b)$ holds, with

$$\sup f(\mathbf{B}_j(\bar{\rho}) \cup \mathbf{S}_k(\bar{\rho})) < a < \inf f(\mathbf{S}'_j(\rho)), \quad \sup f(\mathbf{B}_k(\bar{\rho})) < b < f(\bar{e}_1) + \epsilon.$$

Applying Theorem 2.10 we get the conclusion. □

We are now going to give some more details on the regions of the (α, β) plane for which three solutions exist. To this aim we need to recall the functions ν_k , already introduced in (6.4) of [34].

DEFINITION 5.3. Let $k \in \mathbb{N}$, $j \geq 1$, $e \in H_0^1(\Omega)$, $e \neq 0$, $\alpha \in \mathbb{R}$. We define

$$\Sigma_k^+(e) = \left\{ z = \sigma e + v \mid \sigma \geq 0, v \in H_k^\perp, \|z\|_{H_0^1(\Omega)} = 1 \right\}$$

$$\nu_k(\alpha) = \sup \left\{ \beta \in \mathbb{R} \mid \exists e \text{ in } H_k \text{ with } e \neq 0, \inf Q_{\alpha, \beta}(\Sigma_k^+(e)) > 0 \right\} .$$

The following result is a consequence of (6.5) in [34].

PROPOSITION 5.4. Let $k \geq 1$. We have:

- 1) $\nu_k(\alpha) \in \mathbb{R}$ for every α in \mathbb{R} .
- 2) The function $\nu_k : \mathbb{R} \rightarrow \mathbb{R}$ is continuous, is decreasing, $\nu_k \circ \nu_k = \text{identity}$, $\nu_k(\lambda_k) = \lambda_k$ and

$$\lim_{\alpha \rightarrow +\infty} \nu_k(\alpha) = -\infty, \quad \lim_{\alpha \rightarrow -\infty} \nu_k(\alpha) = +\infty .$$

DEFINITION 5.5. Let $k \geq 1$, $\alpha < \lambda_{k+1}$, $\beta < \lambda_{k+1}$. We set (cfr. (7.5) in [34])

$$\mathcal{N}_k(\alpha, \beta) = \left\{ u \in H_0^1(\Omega) \mid f'(u)(v) = 0 \ \forall v \in H_k^\perp \right\}$$

For the proof of the following proposition see 7.5 in [34].

PROPOSITION 5.6. Let $k \geq 1$, $\alpha < \lambda_{k+1}$, $\beta < \lambda_{k+1}$.

- 1) $\mathcal{N}_k(\alpha, \beta)$ is the graph of a Lipschitz continuous function $\Gamma'_k : H_k \rightarrow H_k^\perp$; moreover for all v in H_k and all w in H_k^\perp $f(v + w) \geq f(v + \Gamma'_k(v))$;
- 2) if $\beta > \nu_k(\alpha)$, then

$$\lim_{\substack{\|u\| \rightarrow \infty \\ u \in \mathcal{N}_k(\alpha, \beta)}} f(u) = -\infty .$$

It is finally possible to prove a multiplicity lemma.

LEMMA 5.7. Let $h, k \in \mathbb{N}$, $k > h \geq 1$ and (α, β) be such that

$$\lambda_h \leq \alpha < \lambda_{h+1}, \ \nu_k(\alpha) < \lambda_{k+1}, \ \nu_k(\alpha) < \beta$$

$$(\alpha, \beta) \in R_{hk}$$

Then for all pairs (α', β') , sufficiently near to (α, β) the corresponding functional f has at least three critical points and two critical levels.

PROOF. Since $\beta > \nu_k(\alpha) < \lambda_{k+1}$, we can find β_1 such that $\beta_1 \leq \beta$, $\nu_k(\alpha) < \beta_1 < \lambda_{k+1}$. As before, for clarity, we denote our functional by $f_{\alpha, \beta}$ to make the dependence on (α, β) explicit. We have

$$\lim_{\substack{\|u\| \rightarrow \infty \\ u \in \mathcal{N}_k(\alpha, \beta_1)}} f_{\alpha, \beta_1}(u) = -\infty$$

because $\beta_1 > \nu_k(\alpha)$ ($\mathcal{N}_k(\alpha, \beta_1)$ does exist, since $\alpha, \beta_1 < \lambda_{k+1}$). Then

$$\lim_{\substack{\|u\| \rightarrow \infty \\ u \in \mathcal{N}_k(\alpha, \beta_1)}} f_{\alpha, \beta}(u) = -\infty$$

which implies that there exists $\bar{\rho}$ such that $\bar{\rho} > 0$ and

$$\sup \{ f_{\alpha, \beta}(v + \Gamma'_k(v)) \mid v \in \mathbf{S}_k(\bar{\rho}) \} < f_{\alpha, \beta}(\bar{e}_1).$$

Moreover, since $\alpha, \beta_1 \geq \lambda_h$, it turns out that

$$\sup f_{\alpha, \beta_1}(H_h) = f_{\alpha, \beta_1}(\bar{e}_1) = f_{\alpha, \beta}(\bar{e}_1)$$

which yields

$$\sup \{ f_{\alpha, \beta}(v + \Gamma'_k(v)) \mid v \in H_h \} = \sup \{ f_{\alpha, \beta_1}(v + \Gamma'_k(v)) \mid v \in H_h \} = f_{\alpha, \beta}(\bar{e}_1).$$

Finally, since $\lambda_h \leq \alpha < \lambda_{h+1}$, there exists ρ such that $\bar{\rho} > \rho > 0$ and

$$f_{\alpha, \beta}(\bar{e}_1) < \inf f_{\alpha, \beta}(\mathbf{S}'_h(\rho)).$$

It is now clear that the topological situation expressed by the above inequalities is quite analogous to the that of (2.10.1). Now take a and b such that

$$f_{\alpha, \beta}(\bar{e}_1) < a < \inf f_{\alpha, \beta}(\mathbf{S}'_h(\rho)), \quad b > \sup \{ f_{\alpha, \beta}(v + \Gamma'_k(v)) \mid v \in \mathbf{B}_k(\bar{\rho}) \}.$$

Using the fact that $(\alpha, \beta) \in R_{kh}$ and Lemma 4.3, we easily obtain that condition $(\nabla)(f_{\alpha, \beta}, H_h \oplus H_k^\perp, a, b)$ holds. Then the conclusion follows for $f_{\alpha, \beta}$ by Theorem 2.10; on the other side, as already noted in the proof of Lemma 4.14, all the assumptions are still true for (α', β') near (α, β) , with the same a and b . This allows to conclude the proof. \square

Using the previous lemma and the properties of R_{hk} the following theorem follows easily.

THEOREM 5.8. *Let $k \in \mathbb{N}$, $k \geq 2$. There exists an open neighbourhood V of the set*

$$\left\{ (\alpha, \beta) \in \mathbb{R}^2 \mid \lambda_1 < \alpha < \lambda_k, \nu_k(\alpha) < \lambda_{k+1}, \nu_k(\alpha) < \beta \leq \lambda_{k+1} \right\}$$

such that, for all (α, β) belonging to it, problem (P) has at least three solutions and the functional f has at least two critical levels.

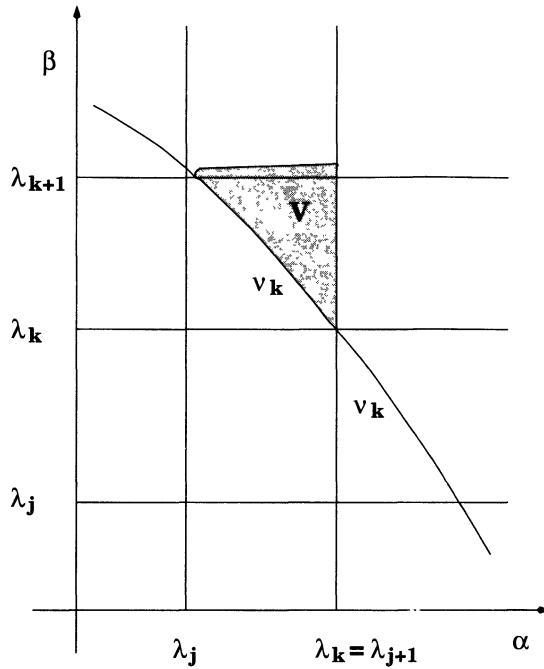

Fig. 9. The three solution region of Theorem 5.8.

6. – Five solutions regions in the (α, β) plane

In Theorems 4.5 and 4.15 we have individuated two classes of regions of the (α, β) -plane with $\beta < \alpha$, to which at least three solutions of problem (P) correspond. We are now going to show that in the (possible) intersections of such regions some new regions can be individuated such that, for (α, β) lying inside them, at least five solutions of problem (P) occur. We will also prove a similar result for $\beta > \alpha$.

Notice that, in particular, between the curves $\beta = \mu_2(\alpha)$ and $\beta = \lambda_1$ there are infinitely many such five solution regions, with α in a right neighbourhood of each λ_i .

In the following theorems we need assumption $(\nabla)(f, H_h \oplus H_j^\perp, a, b)$ to hold, for suitable h, j, a, b and for (α, β) in a neighbourhood of the square $[\lambda_h, \lambda_h] \times [\lambda_k, \lambda_k]$, deprived of the vertices $(\lambda_h, \lambda_h), (\lambda_k, \lambda_k)$. We know, by the previous theorems, that such condition is fulfilled in $[\lambda_h, \lambda_h] \times [\lambda_k, \lambda_k] \setminus \{(\lambda_h, \lambda_h), (\lambda_k, \lambda_k)\}$. but, unlike what done when proving the theorems of Sections 4 and 5, we cannot use Lemma 4.3, which holds in sets where the function f is bounded. Indeed, for the pairs (α, β) we have to deal with, we cannot assume a lower bound on the values of f on the constrained critical points. For this we need another version, of Lemma 4.3.

LEMMA 6.1. Let $j \geq h \geq 1$, $e \in L^2(\Omega)$ and $(\alpha, \beta) \in [\lambda_h, \lambda_{j+1}] \times [\lambda_h, \lambda_{j+1}] \setminus \{(\lambda_h, \lambda_h), (\lambda_{j+1}, \lambda_{j+1})\}$; moreover, in the case where $h = 1$, we also assume $\alpha \neq \lambda_1$ and $\beta \neq \lambda_1$.

Let $((\alpha_n, \beta_n))_n$ and $(u_n)_n$ be sequences such that

$$\begin{aligned} \lim_{n \rightarrow \infty} (\alpha_n, \beta_n) &= (\alpha, \beta), & \lim_{n \rightarrow \infty} P'(u_n) &= 0 \\ \lim_{n \rightarrow \infty} P'' \left(u_n + \Delta^{-1}(\alpha_n u_n^+ - \beta_n u_n^- - e) \right) &= 0 \end{aligned}$$

where P' and P'' are the projections onto $\text{span} \{e_{h+1}, \dots, e_j\}$ ($\{0\}$, if $h = j$) and $H_h \oplus H_j^\perp$ respectively.

Then $(u_n)_n$ is bounded.

PROOF. Assume, by contradiction, that there exist two sequences as above, such that $\|(u_n)_n\|_{H_0^1(\Omega)} \rightarrow \infty$. Set $z_n = \frac{u_n}{\|u_n\|}$. Arguing as in the proof of 4.3, we can suppose that $(z_n)_n$ converges in $H_0^1(\Omega)$ to a point z in $H_h \oplus H_j^\perp$, which must be nontrivial, since $\|u\|_{H_0^1(\Omega)} = 1$. Furthermore we have

$$P''(z + \Delta^{-1}(\alpha z^+ - \beta z^-)) = 0.$$

Let $u = \eta + \vartheta$, with $\eta \in H_h$ and $\vartheta \in H_j^\perp$. Multiplying (6.1.1) by η and ϑ respectively and integrating over Ω , we obtain

$$\begin{aligned} \int_{\Omega} (|D\eta|^2 - \chi(z)\eta^2 - \chi(z)\eta\vartheta) dx &= 0 \\ \int_{\Omega} (|D\vartheta|^2 - \chi(z)\vartheta^2 - \chi(z)\eta\vartheta) dx &= 0 \end{aligned}$$

where

$$\chi(t) = \begin{cases} \frac{\alpha t^+ - \beta t^-}{t} & \text{if } t \neq 0, \\ \frac{\alpha + \beta}{2} & \text{(for instance) if } t = 0. \end{cases}$$

It follows

$$\begin{aligned} 0 &\geq \int_{\Omega} (|D\eta|^2 - \lambda_h \eta^2) dx \geq \int_{\Omega} (|D\eta|^2 - \chi(z)\eta^2) dx \\ &= \int_{\Omega} (|D\vartheta|^2 - \chi(z)\vartheta^2) dx \geq \int_{\Omega} (|D\vartheta|^2 - \lambda_{j+1} \vartheta^2) dx \geq 0 \end{aligned}$$

hence all the terms written above are zero. We claim that $\eta = 0$: if not then η is an eigenfunction of $-\Delta$ with eigenvalue λ_h , in particular $\eta(x) \neq 0$ for almost every x in Ω . This implies that $\chi(z) = \lambda_h$ so either $\beta > \alpha = \lambda_h$ or $\alpha > \beta = \lambda_h$ (α and β cannot both be equal to λ_h). Consider, for instance, the first case. Then $z \geq 0$ and by (6.1.1) z is an eigenfunction of $-\Delta$ with $\alpha = \lambda_h$ as eigenvalue. But this is not possible because $\lambda_h = \alpha > \lambda_1$.

In the same fashion one can prove that $\vartheta = 0$. But then $z = \eta + \vartheta = 0$ and this is contradictory. □

THEOREM 6.2. *Let k, h be integers such that $k > h \geq 1$ and $\lambda_h < \lambda_{h+1} < \lambda_k$. Suppose that $\mu_{h+1}(\lambda_k) > \lambda_h$. Then there exists a neighbourhood U of the segment $\{\lambda_k\} \times [\lambda_h, \mu_{h+1}(\lambda_k)]$ such that, if $(\alpha, \beta) \in U$, $\alpha > \lambda_k$, $\lambda_1 < \beta < \mu_{h+1}(\alpha)$, then problem (P) has at least five solutions and f has at least three critical levels.*

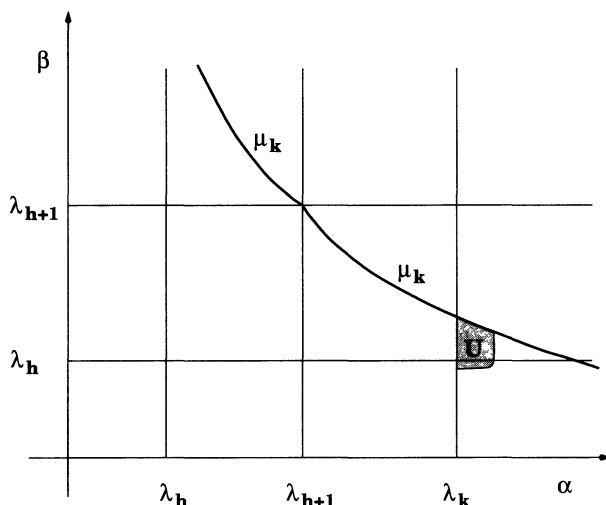

Fig. 10. The five solution region of Theorem 6.2.

PROOF. We may assume that $\lambda_k < \lambda_{k+1}$ and choose j with $\lambda_{h+1} \leq \lambda_j < \lambda_{j+1} = \lambda_k$.

- 1) Let W_k the open set with the properties claimed in Theorem 4.5: if $(\alpha, \beta) \in W_k$ f has three critical points u_1, u_2 and u_3 with $f(u_i) \geq \inf f(\bar{e}_1 + H_j^\perp)$ for $i = 1, 2, 3$.
- 2) Let β' and β'' be such that $\psi_h(\lambda_k) < \beta' < \beta'' < \lambda_k$. Using the formula (3.1.5) we can find ϵ, σ, ρ such that $\epsilon > 0, \sigma > 0, \rho > 0$ and for all (α, β) in $[\lambda_k, \lambda_k + \sigma] \times [\beta', \beta'']$

$$(6.2.1) \quad \sup f(\mathbf{S}_j(\rho)) < f(\bar{e}_1) - \epsilon < \inf f(\bar{e}_1 + H_j^\perp)$$

(by (6.2) and (7.1) in [34], if $\alpha = \lambda_{j+1}$, $\beta < \lambda_{j+1}$, $N_j(\alpha, \beta) = \inf f(\bar{e}_1 + H_j^\perp)$ attains the value $f(\bar{e}_1)$ and is continuous with respect to (α, β)); also using the second expression of $f(\bar{e}_1 + z) - f(\bar{e}_1)$ in (3.1.5), since $\psi_h(\alpha) \leq \psi_h(\lambda_k) < \beta' \leq \beta$, we can also suppose that

$$(6.2.2) \quad \sup \left\{ f(\bar{e}_1 + u) \mid u \in H_h, \|u\|_{H_0^1(\Omega)} \geq \rho \right\} \leq f(\bar{e}_1) - \epsilon$$

- 3) Let (α, β) be such that $\mu_{h+1}(\alpha) > \lambda_h$, $\psi_h(\alpha) < \beta < \mu_{h+1}(\alpha)$ and let β_1 be such that $\beta_1 \geq \beta$, $\lambda_h < \beta_1 < \mu_{h+1}(\alpha)$. Arguing as in 4.14 we can find R such that $R \geq \rho$ and

$$\sup f(\mathbf{S}_h(R)) < \inf f(\mathcal{M}_h(\alpha, \beta_1))$$

- 4) We know that, if $(\alpha, \beta) \in [\lambda_h, \lambda_k] \times [\lambda_h, \lambda_k] \setminus \{(\lambda_h, \lambda_h), (\lambda_k, \lambda_k)\}$ there are no critical points u of $f|_{H_h \oplus H_k^\perp}$ with $f(u) \neq f(\bar{e}_1)$ (see Lemma 4.2); using Lemma 6.1 we easily obtain that there exists a neighbourhood of the set $(\alpha, \beta) \in [\lambda_h, \lambda_k] \times [\lambda_h, \lambda_k] \setminus \{(\lambda_h, \lambda_h), (\lambda_k, \lambda_k)\}$ such that, for all (α, β) in it, $(\nabla)(f, H_h \oplus H_j^\perp, -\infty, f(\bar{e}_1) - \epsilon)$ holds.
- 5) Take a pair (α, β) meeting all the requirements of the previous points. Then the assumptions of Theorem 2.6 (in the case $R = +\infty$) are fulfilled, up to replacing the sphere S_{12} with the (sphere-like) set

$$\tilde{S}_j = \{u \in H_j \mid \text{dist}(u, \mathbf{B}_h(R) \cup \mathbf{B}_j(\rho)) = \delta\}$$

with δ a sufficiently small positive number such that $\sup f(\tilde{S}_j) < f(\bar{e}_1) - \epsilon$. Then there exist two critical points u_4, u_5 for f such that

$$f(u_i) \leq \sup f(\tilde{S}_j) < \inf f(\bar{e}_1 + H_j^\perp) \quad i = 4, 5 \quad \square$$

Now we prove an analogous result for $\alpha < \beta$.

THEOREM 6.3. *Let $h, k \in \mathbb{N}, h > k \geq 2$ and $\lambda_k < \lambda_h < \lambda_{h+1}$.*

Suppose that $v_h(\lambda_k) < \lambda_{h+1}$.

Then there exists a neighbourhood V of the segment $\{\lambda_k\} \times [v_h(\lambda_k), \lambda_{h+1}]$ such that, if $(\alpha, \beta) \in V, \alpha < \lambda_k, \beta > v_h(\alpha)$, then problem (P) has at least five solutions and f has at least three critical levels.

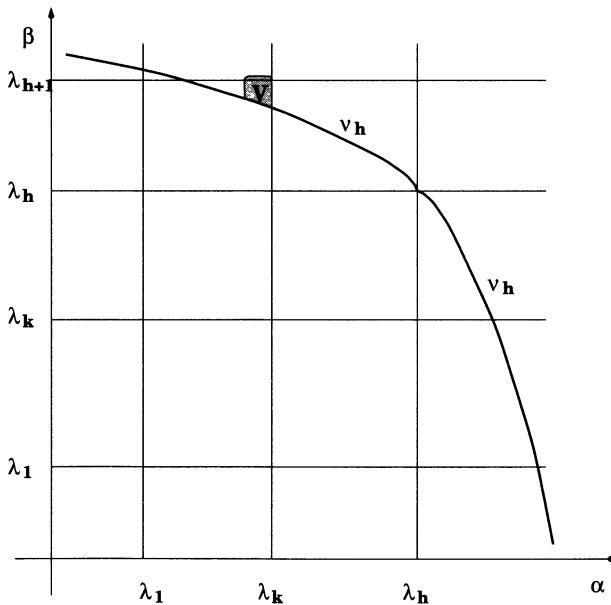

Fig. 11. The five solution region of Theorem 6.3.

PROOF.

- 1) Let V_k be the open set with the properties claimed in Theorem 4.15: if $(\alpha, \beta) \in V_k$, then f has at least three critical points u_1, u_2, u_3 with $f(u_i) \leq \sup f(H_k)$ for $i = 1, 2, 3$.
- 2) Let β', β'' be such that $\lambda_k < \beta' < \beta'' < +\infty$. Then by the first equality in (3.1.5) we have that there exist ρ, ϵ, σ such that $\rho > 0, \epsilon > 0, \sigma > 0$, and for all (α, β) in $[\lambda_k - \sigma, \lambda_k] \times [\beta', \beta'']$

$$\sup f(H_k) < f(\bar{e}_1) + \epsilon < \inf f(\mathbf{S}'_k(\rho)).$$

- 3) Let (α, β) be such that $\beta > v_h(\alpha), v_h(\alpha) < \lambda_{h+1}$ and let β_1 be such that $\beta_1 \leq \beta, v_h(\alpha) < \beta_1 < \lambda_{h+1}$. Then $\mathcal{N}_h(\alpha, \beta_1)$ is well defined and

$$\lim_{\substack{u \in \mathcal{N}_h(\alpha, \beta_1) \\ \|u\| \rightarrow \infty}} f(u) = -\infty$$

as one can easily check, using the same arguments of Lemma 5.7. Then there exists $R > \rho$ such that

$$\sup f(\Gamma'_h(\mathbf{S}_h(R))) < \inf f(\mathbf{S}'_k(\rho)).$$

- 4) As in Step 4 of 6.2, we can find a neighbourhood of the set $[\lambda_k, \lambda_{h+1}] \times [\lambda_k, \lambda_{h+1}] \setminus \{(\lambda_k, \lambda_k), (\lambda_{h+1}, \lambda_{h+1})\}$ such that, for all (α, β) in it, the condition $(\nabla)(f, H_k \oplus H_h^\perp, f(\bar{e}_1) + \epsilon, +\infty)$ holds.
- 5) Let (α, β) be a pair in \mathbb{R}^2 verifying all the properties of the previous steps. It is easy to see that the assumptions of Theorem 2.10 are fulfilled, up to replacing T with the set $\Gamma'_h(\mathbf{S}'_h(R) \cup \mathbf{B}_k(R))$. Hence there exist two additional critical points u_4, u_5 such that $f(u_i) \geq \inf f(\mathbf{S}'_k(\rho)) > \sup f(H_k)$ $i = 4, 5$.

□

REFERENCES

- [1] H. AMANN – P. HESS, *A multiplicity result for a class of elliptic boundary value problems*, Proc. Roy. Soc. Edinburgh A **84** (1979), 145-151.
- [2] H. AMANN – E. ZEHNDER, *Nontrivial solutions for a class of nonresonance problems and applications to nonlinear differential equations*, Ann. Scuola Norm. Sup. Pisa **7** (1980), 539-603.
- [3] A. AMBROSETTI, *Elliptic equations with jumping nonlinearities*, J. Math and Physics **18** (1984), 1-12.
- [4] A. AMBROSETTI – G. PRODI, *On the inversion of some differential mappings with singularities between Banach spaces*, Annals of Mathematics **4** (93) (1972), 231-247.
- [5] A. AMBROSETTI – P. H. RABINOWITZ, *Dual variational methods in critical point theory and applications*, J. Functional Analysis **14** (1973), 349-381.

- [6] A. BAHRI, *Résolution générique d'une équation semilinéaire*, C. R. Acad. de Sci. Paris Sér. A-B **291** 1980.
- [7] M. BERGER – E. PODOLAC, *On the solutions of a nonlinear Dirichlet problem*, Indiana Univ. Math. J. **24** (1975), 837-846.
- [8] C. BERTOCCHI – M. DEGIOVANNI, *On the existence of two branches of bifurcation for eigenvalue problems associated with variational inequalities*, in *Scritti in onore di Giovanni Melfi*, volume 11 of Sci. Mat., pages 35-72. Vita e Pensiero, Milano, 1994.
- [9] G. BORDIGIA, *Problemi Perturbativi in Teoria dei punti Critici*, Master's thesis, Università Cattolica del Sacro Cuore, Fac. S.M.F.N., Brescia, Feb. 1996.
- [10] N. P. CAC, *On trivial solutions of a Dirichlet problem whose jumping nonlinearity crosses a multiple eigenvalue*, J. Diff. Equations **80** (1989), 379-404.
- [11] N. P. CAC, *On a boundary value problem with nonsmooth jumping nonlinearity*, J. Diff. Equations **93** (1991), 238-259.
- [12] K. CHANG, "Infinite Dimensional Morse Theory and Multiple Solution Problems", volume 6 of *Progress in Nonlinear Differential Equations and Their Applications* Birckhäuser, Boston, Basel, Berlin, 1991.
- [13] D. G. COSTA – D. G. DE FIGUEIREIDO – P. N. SRIKANTH, *The exact number of solutions for a class of ordinary differential equations through Morse index theory*, J. Diff. Equations **96** (1992), 185-199.
- [14] E. N. DANCER, *On the Dirichlet problem for weak nonlinear elliptic partial differential equations*, Proc. Roy. Soc. Edinburgh A **76** (1977), 283-300.
- [15] E. N. DANCER, *On the ranges of certain weakly nonlinear partial differential equations*, Journal de Mathématiques Pures et Appliquées **57** (1978), 351-366.
- [16] E. N. DANCER, *Multiple solutions of asymptotically homogeneous problems*, Annals of Mathematics **57** (1988), 63-78.
- [17] E. N. DANCER, *A counterexample to the Lazer-McKenna conjecture*, Nonlinear Anal., Theory, Methods and Applications **13** (1989), 19-21.
- [18] E. N. DANCER, *Generic domain dependence for nonsmooth equations and the open set problem for jumping nonlinearities*, Topological Meth. Nonlinear Anal. **1** (1993), 139-150.
- [19] D. G. DE FIGUEIREIDO – J. P. GOSSEZ, *On the First Curve of the Fuik Spectrum of an Elliptic Operator*, preprint, 1994.
- [20] S. FUČIK, *Nonlinear equations with noninvertible linear part*, Czechoslovak Math. J. **24** (1974), 467-495.
- [21] S. FUČIK, *Boundary value problems with jumping nonlinearities*, Časopis Pšt. Mat. **101** (1976), 69-87.
- [22] T. GALLOUET – O. KAVIAN, *Résultats d' existence et de non existence de solutions pour certain problèmes demi-linéaire à l' infini*, Ann. Fac. Sci. Toulouse **3** (1981), 201-246.
- [23] J. A. HEMPEL, *Multiple solutions for a class of nonlinear boundary value problems*, Indiana Univ. Math. J. **20** (1971), 983-996.
- [24] H. HOFER, *Variational and topological methods in partially ordered Hilbert spaces*, Math. Ann. **261** (1982), 493-514.
- [25] J. L. KAZDAN – F. W. WARNER, *Remarks on some quasilinear elliptic equations*, Comm. Pure Appl. Math. **28** (1975), 567-597.
- [26] A. C. LAZER – P. J. MC KENNA, *On the number of solutions of a nonlinear Dirichlet problem*, J. Math. Anal. Appl. **84** (1981), 282-294.

- [27] A. C. LAZER – P. J. MC KENNA, *On a conjecture related to the number of solutions of a nonlinear Dirichlet problem*, Proc. Roy. Soc. Edinburgh **95** (1983), 275-283.
- [28] A. C. LAZER – P. J. MC KENNA, *Critical point theory and boundary value problems with nonlinearities crossing multiple eigenvalues I*, Comm. in Partial Differential Equations **10** (1985), 107-150.
- [29] A. C. LAZER – P. J. MC KENNA, *Critical point theory and boundary value problems with nonlinearities crossing multiple eigenvalues II*, Comm. in Partial Differential Equations **11** (1986), 1653-1676.
- [30] J. LIU, *Bifurcation for potential operators*, Nonlinear Anal., Theory, Methods and Applications **4** (1990), 345-353.
- [31] L. LUSTERNIK – L. SCHNIRELMANN, “Méthodes Topologiques dans le Problèmes Variationnelles”, Hermann, Paris, 1934
- [32] C. A. MAGALHAES, *Semilinear elliptic problems with crossing of multiple eigenvalues*, Comm. in Partial Differential Equations **15** (1990), 1265-1292.
- [33] A. MARINO – A. MICHELETTI – A. PISTOIA, *Some variational results on semilinear problems with asymptotically nonsymmetric behaviour*, in *Nonlinear Analysis, A Tribute in Honour of Giovanni Prodi*, pages 243-256. S. N. S. Pisa, 1991.
- [34] A. MARINO – A. MICHELETTI – A. PISTOIA, *A nonsymmetric asymptotically linear elliptic problem*, Topological Meth. Nonlinear Anal. **4** (1994), 289-339.
- [35] A. MARINO – A. MICHELETTI – A. PISTOIA, *Sul numero e anche sulla molteplicità delle soluzioni di alcuni problemi ellittici asintoticamente lineari e non simmetrici*, in *Proceedings of the congress: “Variational Methods in Nonlinear Analysis and Differential Equations” held in Genova, June 1993*, pages 123-141. E.C.I.G., 1994.
- [36] A. MARINO – A. MICHELETTI – A. PISTOIA, *On some elliptic asymptotically linear and nonsymmetric problems*, Atti Sem. Mat. Fis. Univ. Modena **XLIII** (1995), 401-423.
- [37] A. MARINO – D. PASSASEO, *A jumping behaviour induced by an obstacle*, in M. GIRARDI – M. MATZEU – F. PACELLA (Editors) *Progress in Variational Methods in Hamiltonian Systems and Elliptic Equations*, pages 127-143. Pitman, 1992.
- [38] A. MARINO – C. SACCON, *Alcuni teoremi variazionali di tipo misto e un problema ellittico asintoticamente asimmetrico*, Atti Sem. Mat. Fis. Univ. Modena, to appear.
- [39] A. MICHELETTI, *A remark on the resonance set for a semilinear elliptic equation*, Proc. Roy. Soc. Edinburgh A **124** (1994), 803-809.
- [40] A. MICHELETTI – A. PISTOIA, *A variational viewpoint on the existence of three solutions for some elliptic problems*, Differential and Integral Equations **6** (1995), 67-80.
- [41] A. MICHELETTI – A. PISTOIA, *A note on the resonance set for a semilinear elliptic equation and an application to jumping nonlinearities*, Topological Meth. Nonlinear Anal. **9** (5) (1996), 1029-1042.
- [42] M. MORSE – S. S. CAIRNS, “Critical Point Theory in Global Analysis and Differential Topology”, Academic Press, New York, 1969.
- [43] R. PALAIS, *Morse theory on Hilbert manifolds*, Topology **2** (1963), 299-340.
- [44] P. H. RABINOWITZ, “Minimax Methods in Critical Point Theory with Applications to Differential Equations” volume 65 of *Regional Conference Series in Mathematics*, American Mathematical Society, Providence, R. I., 1986.
- [45] M. RAMOS, *A critical point theorem suggested by an elliptic problem with asymmetric nonlinearities*, preprint.

- [46] B. RUF, *On linear elliptic problems with jumping nonlinearities*, *Annals of Mathematics* **4** (1981), 133-151.
- [47] B. RUF, *Remarks and generalizations related to a recent result of A. Lazer and P. J. McKenna* *Nonlinear Anal., Theory, Methods and Applications* **9** (1985), 1325-1330.
- [48] M. SCHECHTER – K. TINTAREV, *Pairs of critical points produced by linking subsets with application to semilinear elliptic problems*, *Bull. Soc. Math. Belg. B* **44** (1992), 249-261.
- [49] S. SOLIMINI, *Existence of a third solution for a class of b. p. v. with jumping nonlinearities*, *Nonlinear Anal., Theory, Methods and Applications* **7** (1983), 917-927.
- [50] S. SOLIMINI, *Some remarks on the number of solutions of some semilinear elliptic problems*, *Ann. Inst. Henri Poincaré* **2** (1985), 143-156.

Dipartimento di Matematica
Via Buonarroti 2
I-56127 Pisa, Italy

Dipartimento di Matematica
Via D'Azeglio 86A
I-43100 Parma, Italy